

Prince William County Preconstruction Package



Site Development Inspection Requirements

Rev. 02/23/2021

Please be advised that while every effort has been made to include the most recent information in this package, forms and fees are subject to revision at any time. It is solely the responsibility of the permittee to ensure that the forms and fees tendered are current and correct.



COUNTY OF PRINCE WILLIAM

5 County Complex Court, Suite 30, Prince William, Virginia 22192
Environmental Services (703) 792-7070 Transportation Department (703) 792-6825
Site Inspection Fax Number (703) 792-7012

Pre-Construction Meeting Requirements:

As requested, you've been invited to a pre-construction meeting on the emailed herein date and time. The meeting will take place at 5 County Complex Ct., Suite 30., Prince William, VA 22192.

For said meeting, please have the following:

Personnel Required:

- Owner or Representative.
- Developer or Representative.
- Contractor or Representative.
- Responsible Land Disturber (**RLD**, Virginia Certified, Certification Number).
- 24 Hour Emergency Contact.
- Civil Engineer.
- Geotechnical Engineer.

Paperwork Required:

- **Approved Site Plan.**
- **VDOT Entrance Permit** (must be obtained prior to work beginning unless an existing entrance is to be used).
- **SWPPP** (Storm Water Pollution Prevention Plan). (1 Acre or greater).
- **Army Corps of Engineers, Wetland** and all other applicable or permits.
- **DEQ Registration Statement General VPDES Permit** (1 Acre or greater, Filled out).
- **DEQ Construction Activity Operator Permit Fee Form** (1 Acre or greater, Filled out).
- **PWC Preconstruction Transmittal** filled out.

During the meeting, we'll discuss several topics including, but not limited to, the specifics of the project and general state and local regulatory requirements and – permit conditions – as they relate to (E/S) and storm-water control. In addition, the County's Transportation Department representative(s) will further discuss their inspections processes and applicable regulatory conditions pertaining to the proposed work.



COUNTY OF PRINCE WILLIAM

5 County Complex Court, Suite 30, Prince William, Virginia 22192
Environmental Services (703) 792-7070 Transportation Department (703) 792-6825
Site Inspection Fax Number (703) 792-7012

Furthermore, it will be an ideal opportunity to raise questions regarding the proposed sequence of construction, developer's needs and plan, and general regulatory enforcement topics. And, of course, any other subjects or concerns that we may be able to assist you with.

As noted above, a follow up e-mail will be sent containing specific forms and documentation listed above that will need to be completed and reviewed by the permit holder. Also, although not likely, you may receive an updated invitation request should we need to reschedule or update the date, time or location said meeting will take place. Should you have any questions or need to reschedule, please reach out to us promptly. We look forward to assist you and your client with getting this project underway, and thank you for choosing Prince William County for your construction and development needs!

Sincerely,

Site Inspections,

This Page Has Been Intentionally Left Blank

Preconstruction Table of Contents

1. Minimum Inspection Program requirements (7/16/2012)

2. Attachments:

a. Testing

1. Minimum testing requirements (1/11/2018)

2. Use of expansive soils (7/1/2010)

b. General

1. Noise Ordinance Excerpts (4/2/2012)

1a. Noise Ordinance Exemption Request (7/1/2010)

1b. Noise Ordinance posting requirement (7/1/2010)

2. Cut sheet requirements (7/1/2010)

3. TSS-1 through street sign standard exhibit DCSM 650.47 (7/1/2010)

4. Prince William County snow removal policy for active projects (7/1/2010)

5. Checklist for Final Inspection and Bond Release (10/20/2017)

5a. Flowchart for final inspection and bond release (10/20/2017)

6. Instructions for Bond and Escrow extension and/or reduction requests (7/1/2017)

7. Asphalt Pavement Widening exhibit DCSM 650.56 (7/1/2010)

8. Placement of Utilities (4/2/2012)

9. Fire Marshall's Office Requirements (7/16/2012)

c. Occupancy

1. General Street Lighting Notes (7/1/2017)

2. Street Lighting Agreement (5/1/2017)

3. General requirements for Occupancy (2/11/2011)

3. Requirements for opening a new road to the general public (7/1/2010)

4. Concrete and Open Cut Policy (7/30/2018)

5. Concrete and Open Cut Fee Form (1/23/2020)

6. Occupancy Phasing Guidelines (7/30/2018)

7. Fee Verification for Occupancy Phasing Plans (Phasing Plan Request) (7/01/2020)

8. Site Inspection Request (7/01/2020)

d. VDOT Acceptance

1. Checklist for Street Acceptance Paper Review in Prince William County (12/6/2017)
2. Project Data Sheet – Prince William County (12/6/2017)
3. Segment Data Sheet – Prince William County (4/2/2012)
4. Clarification of VDOT eligibility for street acceptance (7/1/2010)
5. Requirement for Structure Inspection (total opening > 36 SF) (7/1/2010)
6. VDOT Begin (End) State Maintenance Sign Exhibit (7/1/2010)
7. Deleted
8. LUP-IPP (VDOT utility permit) (7/1/2010)
9. Obtaining a Land Use Permit for landscaping in the Right of Way (7/1/2010)
10. Flowchart for landscaping in the Right of Way (4/2/2012)
- 11a & 11b. PWC Landscape Maintenance Agreements (4/30/2018)
12. Example of cash escrow computation for landscaping in the Right of Way (7/30/2018)
13. LUP-A (VDOT Landscape Permit) (7/1/2010)
 - 13a. LUP-LSP (VDOT Landscape Special Provisions) (5/31/2011)
14. Guidelines for irrigation within the VDOT Right of Way (5/31/2011)
15. VDOT flowchart for street acceptance (7/16/2012)
16. Route number placement exhibit - DCSM 650.45 (per DCSM 604.06A, not included) (7/1/2010)
17. VDOT policy for use of metal signposts (7/1/2010)
 - 17a. VDOT Square Tube Sign Post Detail STP-1 (4/22/2013)
18. VDOT Post Installation Inspection of Storm Drain Pipe and Pipe Culverts (7/1/2010)
19. LUP-OCPR Open Cut Pavement Restoration Detail (5/31/2011)
20. Subordination of Rights Agreement (7/16/2012)
21. VDOT testing certification requirement (8/2/2017)

e. Phased Construction

1. VDOT's letter concerning Phased Construction of Subdivision and Secondary Streets (7/16/2012)
2. Clarification of staged surfacing of subdivision and secondary streets – DCSM 602.11H (7/1/2010)

f. Warranty Bonds

1. VDOT's letter concerning Accepting Streets with Outstanding Violations (7/16/2012)

g. Watershed Management

00. Fee Schedule (7/01/2020)
1. Inspection/Right of Entry Notice (7/12/2013)
2. Project Inspection Overview (7/12/2013)
3. Responsible Land Disturber Contact Information (7/12/2013)
4. Bi-weekly RLD report (7/12/2013)
5. Daily Fill Observation Report (7/12/2013)
6. Impervious Area Calculation (7/01/2020)
7. Temporary Stockpile Policy (7/12/2013)
8. Application for Construction within a Storm Water Management Easement (7/01/2020)
9. As-built Submission Requirements (7/01/2020)
10. Intentionally Left Blank
11. Storm Sewer CCTV Policy, Procedure and Application (7/01/2020)
12. Variance Request Application (7/01/2020)
13. As-built Plan Acceptance Confirmation/Transmittal (7/01/2020)
14. Approved As-built Plan Pick-up Confirmation/Transmittal (7/01/2020)
15. As-Built Checklist (7/16/2012)
16. BMP Installation Process and Guideline (7/01/2020)

NOTES: References taken from PWC DCSM effective 2/5/2011.
Dates in parentheses are current revision/effective dates



COUNTY OF PRINCE WILLIAM

5 County Complex Ct. Prince William, VA 22192-5308
(703) 792-6820 Metro 631-1703 Fax 792-6828

The minimum Inspection Program requirements are as follows:

1. The developer/developer's representative shall be accessible to Prince William County (PWC) personnel at any time as needed.
2. Prior to commencement of land disturbance activity, the developer/developer's representative shall assure that appropriate erosion control devices are installed in accordance with approved plans and signed off by the site inspector. The developer is also responsible for effectively maintaining the erosion control devices in accordance with the requirements of the Virginia Erosion and Sediment Control Handbook throughout the life of the project.
(Virginia Administrative Code 4VAC50-30-60)
3. Comprehensive projects (those projects with streets dedicated to public use) shall comply with the Virginia Department of Transportation (VDOT) approved Comprehensive Inspection Program through compliance with testing requirements.
4. The project shall comply with Prince William County's current Design and Construction Standards Manual (DCSM) and VDOT's current standards and specifications. PWC and VDOT (comprehensive) shall review and approve any changes to the approved plans prior to construction.
5. The project shall comply with all applicable proffers, provisions of the developer's performance bond agreements, erosion and sediment control and landscaping escrow agreements prior to bond release. (Administrative Procedures Manual 4.07.5)
6. All roadway construction materials shall come from VDOT approved sources. Prior to installation, the developer will furnish the manufacturers or producer's certifications to PWC site inspector for verification that the materials utilized (storm sewer pipe and structures, liquid asphalt, etc.) meet VDOT's current standards and specifications. Certified cut sheets are to be presented to the PWC site inspector prior to placement of storm sewer (attachment b2).
7. All pavement designs for streets with traffic volume exceeding one thousand (1,000) vehicles per day (vpd) shall provide 21B, Type I aggregate as subbase or base material. This will also necessitate consideration of underdrains in the design. (DCSM 602.10 E)
8. It shall be the developer's responsibility to coordinate with all builders in his/her development to ensure that construction within the dedicated right-of-way conforms to the standards and specifications of PWC and VDOT. The developer should urge builders to contact the site inspector for inspection of driveway entrances and sidewalks prior to construction.

9. To facilitate schedule integration a minimum of 48 working hours notice to the inspector is required for CBR sample acquisition, aggregate and asphalt paving and hydraulic cement concrete placement. The developer shall also be responsible for overtime pay if the inspector is needed outside regular working hours.
10. Prior to the preliminary acceptance walk with VDOT personnel, a "Documentation Review" meeting is required with the PWC site inspector and VDOT. It is the developer's responsibility to provide all applicable documentation as detailed on **attachment d1**. As part of the applicable documentation, a Draft Resolution must be prepared; in order to facilitate this preparation a Recorded Plat and an overall view not to exceed 24" x 36" must be submitted to the PWC site inspector *prior* to the inspector contacting VDOT to schedule the review meeting. The plat must be legible, to scale, contain all line and curve data and contain an instrument number or deed book, page number, and recordation date. In addition, all streets to be considered for acceptance are to have the centerlines highlighted, and ties to any existing VDOT maintained street(s) clearly marked. **This draft resolution will be valid for one (1) year.**
11. Prior to the issuance of Occupancy the street lights shall be installed as shown on the approved plans or as amended by the Street Lighting Program Coordinator. (attachment c1)
12. The developer shall comply with the requirements of the attached flow chart for landscaping located within the dedicated right-of-way but not eligible for VDOT maintenance. (attachment d10)
13. The developer shall comply with the VDOT letter of March 26, 2012, concerning phased construction of subdivision and secondary streets. (attachment e1)
14. The developer shall inform the contractor(s) of the need to keep all temporary fueling tanks secured and located away from live streams, wetlands and RPA's. Fueling stations are to be constructed in such a manner that they are surrounded by an earthen berm to prevent an environmental event.
15. The developer shall have a copy of the applicable permits, approved site plan and a current issue of the PWC Design and Construction Standards Manual on site and available.
16. Requests made for a Performance Bond reduction or extension shall be accompanied by a current estimate for work left to be completed, along with a copy of the proffers and current proffer analysis. (Administrative Procedures Manual 4.07.4)
17. **TESTING:** Tests for density and/or concrete are to be submitted on PWC approved forms only. Insure that all test reports have only one project section per page attached. Multiple project sections on the same page will not be accepted.
18. Watershed Management requires that the developer contact the inspector when the site is flagged for clearing. A joint inspection shall be made with the developer and inspector to insure that limits are correct.

19. Where applicable, it is the developer's responsibility to provide and install "End (or Begin) State Maintenance" signs as directed by the VDOT inspector. (attachment d6)

20. Streets that are ultimately to be extended to provide access to adjacent development shall be posted indicating possible extension of the street per DCSM 604.04. (attachment b3)
21. VDOT policy requires a Post Installation Inspection of Storm Drain Pipe and Pipe Culverts consisting of a camera inspection and documentation of any comprehensive streets. Details are located in Virginia Test Method - 123. (attachment d18)
22. Any utility repairs requiring open cutting of the street shall comply with VDOT's LUP-OCPR Open Cut Pavement Restoration Detail. (attachment d19)
23. All ties to existing asphalt pavement shall conform to DCSM 650.56. (attachment b7)
24. All testing shall be performed by technicians certified through VDOT or through a program recognized by VDOT. WACEL certification is not currently recognized. (attachment d21)

PRINCE WILLIAM COUNTY

Minimum Testing Requirements for Comprehensive Street Inspections **All testing must comply with current VDOT and PWC DOT specifications**

CBR's

Test method

All CBR values are to be determined in accordance with "The Virginia Test Method for Conducting California Bearing Ratio Tests" (Designation VTM-8). For each roadway, a sufficient number of CBR tests must be conducted to determine the average CBR value for the various soil types anticipated to be in the subgrade.

Soil Sampling

Representative soil samples for CBR tests shall be taken from the top 12 inches of the finished subgrade by a qualified soils technician or engineer.

Soil Sample Frequency

- 1) For streets less than 200 feet in length, one soil sample for conducting AASHTO soil classification and CBR test is required.
- 2) For streets 200 to 500 feet in length, at least two soil samples for conducting AASHTO soil classification and CBR tests is required, which includes one at each intersection of an existing state road.
- 3) For longer streets, one soil sample shall be taken at each intersection with an existing state road plus one test sample every 500 feet in length, or portion thereof, is required for conducting AASHTO soil classification and CBR tests.

A sample must be obtained for each soil type present in the subgrade. A representative of Prince William County must be present when samples are obtained.

EMBANKMENTS

General Requirements

Embankment shall not contain muck, frozen material, roots, sod, or other deleterious material. Embankment shall not be placed on frozen ground or areas covered with ice or snow.

When excavated material consists predominantly of soil, embankment shall be placed in successive uniform layers not more than 8 inches in thickness before compaction over the entire roadbed area. Each layer shall be compacted within a tolerance of ± 20 percent of optimum moisture content to a density of at least 95 percent of the theoretical maximum density as defined in Section 101.02 (Road and Bridge Specifications).

The surface area directly beneath the pavement and shoulders on which embankments of less than 5 feet in depth are to be constructed shall be denuded of vegetation. These areas shall be scarified and compacted to a depth of 6 inches to the same degree as the material

to be placed thereon. Rock not more than 4 feet in its greatest dimension may be placed in an embankment to within 10 feet of the subgrade. The remainder of the embankment to within 2 feet of the subgrade shall not contain rock more than 2 feet in its greatest dimension. Each layer shall be constructed so that rock voids are filled with rock spalls, rock fines, and earth. Rock shall be placed, manipulated, and compacted in uniform layers. However, density requirements may be waived. Rock, rock spalls, rock fines, and earth shall be distributed throughout each embankment layer and manipulated as specified herein so that the voids are filled. Rock shall not be end dumped over the edges of the layer being constructed but shall be deposited on the layer and moved ahead so as to advance the layer with a mixture of rock, rock spalls, rock fines, and earth. The 2 feet of the embankment immediately below the subgrade shall be composed of material that can be placed in layers of not more than 8 inches before compaction and compacted as specified herein for embankments. Rock more than 3 inches in its greatest dimension shall not be placed within 12 inches of the subgrade in any embankment.

Testing Frequencies

Embankment *

One test per 2,500 cubic yards or less plus:

- (a) for fills less than 500 ft. one density test per every other 6in. layer bottom to top of fill starting with the second lift.
- (b) for fills from 500-2000 ft. two tests per 6 in. layer within the top 5 ft. of fill.
- (c) for fills greater than 2000 ft., break into equal segments not to exceed 2000 ft. and use same frequency as (b) above.

Backfill for Pipes and Box Culverts *

Minimum one test per lift on alternating sides of structure for each 300 linear feet or portion thereof in structure length, starting after first 4 inch layer above bedding and continue to 1 foot above the top of the structure.

Backfill for Drop Inlets *

To include Drop Inlets, Junction Boxes, etc. Minimum one test every other lift around the perimeter of the structure after first 4-in. layer above bedding and continue to top of structure.

Backfill for Manholes *

Minimum one test (around the perimeter of the structure) every fourth compacted layer until the top five feet of the structure after first 4-in. layer above bedding and continue to the top of the structure. Top five feet shall have one test every other lift around the structure to the top of structure.

Sanitary Sewer and Water Laterals *

One test per 10 laterals.

Other Utilities (Telephone, Gas, etc.) *

One test per street crossing.

Finished Subgrades (Both cut and fill)

General Requirements/Density *

In the finished subgrade in both cut and fill sections, a minimum of one test shall be made for each 1000 linear feet of subgrade for each roadway (full width). The amount of rock present in the embankment that will preclude conducting the density test should remain flexible, and should be at the discretion of the Project Inspector. However, it should be understood that if it is possible to conduct a test, then the test should be conducted. If a test can not be conducted, location documentation of the rock layer shall be submitted in lieu of the test data on the appropriate density report.

The subgrade area shall be scarified to a depth of 6 inches for a distance of 2 feet beyond the proposed edges of the pavement on each side. If sandy or other soil is encountered that will not compact readily, clay or other suitable material shall be added or water applied in such quantity and within the allowable moisture content specified herein as will permit compaction of the subgrade. Subgrade material shall be compacted at optimum moisture, within ± 20 percent of optimum. The density of the subgrade when compared to the theoretical maximum density as determined in accordance with the requirements of VTM-1 shall conform to the following:

% Retained on No. 4 Sieve Min.	% Density
0-50	100
51-60	95
61-70	90

If lime is to be utilized for drying or stabilization, refer to attachment a3.

Depth

Stabilized subgrade shall be tested for proper depth at intervals not to exceed 0.5 mile per paver (mixer) application width.

NOTE: Prior to the placement of sub-base material, the geotechnical testing firm of record shall provide a signed and sealed letter to the PWC DOT inspector stating that any and all undercuts and/or soil modification required by the approved pavement design have been completed, the replacement material is suitable and the geotechnical firm is accepting the work.

AGGREGATE

General Requirements/Density

Where the required thickness is more than 6 inches, the material shall be spread and compacted in two or more layers of approximately equal thickness. The compacted thickness of any one layer shall not exceed 6 inches except when vibrating or other approved types of special compacting equipment are used. In such event, the compacted depth of a single layer of the base course may be increased to 10 inches upon the approval of the Engineer.

After mixing and shaping, each layer shall be compacted at optimum moisture within ± 2 percentage points of optimum. The density of each layer of base aggregate material, when compared to the theoretical maximum density as determined in accordance with the requirements of VTM-1, shall conform to the following:

%Material Retained on No. 4 Sieve	Min.%Density
0-50	100
51-60	95
61-70	90

Cement stabilization will not be permitted when aggregate or the surface on which the course is to be placed is frozen. Manipulation operations shall not be started until the air temperature is at least 40 degrees F in the shade and rising. When material may be exposed to freezing temperatures during the first 24 hours of curing, the Contractor shall protect the stabilized material from freezing for 7 days or shall cover the stabilized surface with the next pavement course within 4 hours after the cement stabilization has been finished as specified.

Protecting and Curing: The next course may be placed after the cement stabilization has been approved. In the event the next pavement course is not placed immediately, the cement-treated aggregate course shall be moist cured continually or covered by the application of liquid asphalt to prevent surface drying until the next pavement course is placed. The Contractor shall endeavor to place the next pavement course within 7 days after cement stabilization is finished. In the event this is not possible and a liquid asphalt cover has not been applied, the Contractor shall either seal the cement-stabilized layer with approved cover material or continually maintain the surface of the cement-stabilized course with moisture until the next pavement course can be successfully applied. The surface of the cement-treated aggregate course shall be maintained in such a manner that the entire surface of the course remains in a moistened condition.

Prior to placing the next course or applying asphalt cover material, the surface of the cement-stabilized layer shall be lightly moistened. In no case shall the cement-treated aggregate course be allowed to dry out completely or go uncovered through the winter. The stabilized course shall be tightly knit and free from loose and extraneous material.

Testing will be performed in accordance with the current Virginia Test Methods Manual and VDOT Road and Bridge Specifications.

Depth

One test per 0.5 miles of material per paver application width per layer.

BITUMINOUS CONCRETE

General Requirements

The Contractor shall perform roller pattern and control strip density testing on surface, intermediate, and base courses in accordance with the requirements of VTM-76. The Contractor shall have a certified Asphalt Field Technician perform all density testing.

Density

Density testing will be performed in accordance with the current Virginia Test Methods Manual and VDOT Road and Bridge Specifications.

Depth

Tests are to be taken at intervals not to exceed 1000 feet per street.

HYDRAULIC CEMENT CONCRETE

General Requirements

Concrete shall not be placed against surfaces whose temperature is below 40 degrees F.

Concrete shall be protected from rain.

Concrete shall be protected from freezing by approved coverings and, when necessary, heating the surrounding air in such a manner that the concrete will not dry.

Curing Concrete:

Membrane-forming compounds: The entire surface of the pavement shall be sprayed uniformly with a white-pigmented membrane-forming compound immediately following the texturing operation.

PE film: When PE film is used for curing, it shall be white. However, from November 1 to April 1, clear or opaque PE film will be permitted.

Protection in cold weather: The Contractor shall prevent the temperature at the surface of the concrete from falling below 40 degrees F during the first 72 hours immediately following concrete placement. Protective material shall be left in place for an additional 48 hours if freezing air temperatures are expected to continue. Such protection shall be furnished in addition to the curing material required elsewhere in these specifications. Within 3 to 7 days, the Contractor shall backfill curb, gutter, and combination curb and gutter to the required elevation with approved material. Backfill material shall be compacted with curbs and gutters remaining plumb.

Curing in hot, low-humidity, or windy weather: Care shall be taken in hot, dry, or windy weather to protect the concrete from shrinkage cracking by applying the curing medium at the earliest possible time after finishing operations and after the sheen has disappeared from the surface of the pavement.

STRUCTURAL CONCRETE

Air Content

One test per truck, and when making compressive specimens.

Slump

One test per truck, and when making compressive specimens.

Compressive Strength

One set of 3 cylinders per 100 cubic yards, with a minimum of 2 sets per class of concrete. Any one set to be made from the same batch.

INCIDENTAL CONCRETE

Air Content

One test per day and when making compressive specimens.

Slump

One test per day and when making compressive specimens.

Compressive Strength

One set of 3 cylinders per 250 cubic yards, with a minimum of 1 set per project. Any one set to be made from the same batch.

* Field density determinations will be performed in accordance with the requirements of AASHTO T191, modified to include material sizes used in the laboratory determination of density, with a portable nuclear field density testing device or by other approved methods. When a nuclear device is used, density determinations for embankment material will be related to the density of the same material tested in accordance with VTM-1 or VTM-12 and a control strip will not be required.

NOTE: All testing must be coordinated with the appropriate Prince William County inspector. All private testing technicians must possess VDOT materials certifications.



PRINCE WILLIAM COUNTY
DEPARTMENT OF TRANSPORTATION
5 County Complex Ct., Suite 290
Prince William, VA 22192

Effective Date
1/11/2018

GEOTECHNICAL CERTIFICATION FOR UNDERCUTS AND/OR SOIL MODIFICATION

The Prince William County Preconstruction Package Minimum Inspection Program, Item #2a1 for Finished Subgrades (Both cut and fill) note, states as follows:

Prior to the placement of sub-base material, the geotechnical testing firm of record shall provide a signed and sealed letter to the Prince William County Department of Transportation Inspector stating that all undercuts and/or soil modification required by the approved pavement design have been completed, the replacement material is suitable and the geotechnical firm is accepting the work.

In lieu of the aforementioned letter, the geotechnical engineer of record shall complete and sign the information below, certifying that the undercuts and/or soil modification are completed and suitable as per the approved pavement design for the road.

Project: _____ Plan #: _____

Geotechnical Engineer (Print): _____

Signature: _____ Date: _____

Seal:

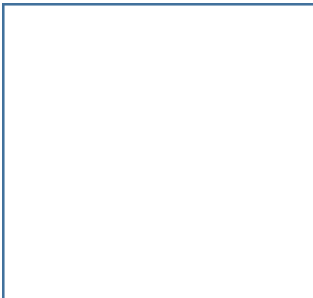

Right-of-Way Locations: _____

This certification shall be signed, sealed and given to the Site Inspector prior to placement of sub-base material.





COUNTY OF PRINCE WILLIAM
4379 Ridgewood Center Drive, Prince William, V a 22192-5308
(703) 7924820 Metro 631-1703 Fax (703) 7924828

DEPARTMENT OF
PUBLIC WORKS

Thomas Bruun
Acting Director

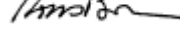
TO: Developers, Builders, Architects and Engineers

FROM: Thomas Bruun  Eric M. Mays, P. E. 
Acting Director of Public Works Building Official

RE: Policy and Procedure 1-01-06
Use of Lime for Drying and Stabilization of Soil
(Effective March 8, 2006/Revised March 21, 2006)

This is to establish the policy for use of lime for drying and stabilization of soil used as structural fill for roads, buildings and other structures. This policy is effective immediately. All on-going construction is subject to this policy.

Geotechnical Engineering Report

The geotechnical engineering report submitted to the County for approval shall address the proposed use of lime for a project/subdivision. Following are the three general categories for the proposed use of lime:

1. Drying of Non-Expansive Suitable Structural Fill Material - The soil meets the standards of suitable structural fill material as established by the VDOT Road and Bridge Specifications, Virginia Uniform Statewide Building Code, the County's Design and Construction Standards Manual, and project documents. There are no expansive soils located within the limits of the site work.
2. Drying of Non-Expansive Suitable Structural Fill Material with Expansive Soils Present - The soils meet the standards of suitable structural fill material as established by the VDOT Road and Bridge Specifications, Virginia Uniform Statewide Building Code, the County's Design and Construction Standards Manual, and project documents. There are expansive soils located within the limits of the site work, and the report must identify how the site work will be managed to prevent the use of the expansive material.

An Equal Opportunity Employer Printed on Recycled Paper



3. Stabilization of Expansive Soils

- ◆ **VDOT Right-of-Way** – VDOT has approved the Fairfax County Stabilization of Expansive Soils with Lime for Roads, dated October 20, 1989 as an acceptable standard for the stabilization of “marine” and “blackjack” clays within the right-of-way. Prince William County hereby adopts the Fairfax County policy for road construction.

- ◆ **Virginia Uniform Statewide Building Code (VUSBC)** – The VUSBC, International Building Code, Section 1805.8 Design for Expansive Soils allows the stabilization of soil when approved by the Building Official. Expansive soils are defined as:

“Soils meeting all four of the following provisions shall be considered expansive, except that tests to show compliance with Items 1,2 and 3 shall not be required if the test prescribed in Item 4 is conducted:
1. Plasticity Index (PI) of 15 or greater, determined in accordance with ASTM D 4318.
2. More than 10 percent of the soil particles pass a No. 200 sieve (75 mm), determined in accordance with ASTM D 422.
3. More than 10 percent of the soil particles are less than 5 micrometers in size, determined in accordance with ASTM D 422.
4. Expansion Index greater than 20, determined in accordance with ASTM D4829.”

- ◆ The Geotechnical Engineering Report/Specifications shall:
 1. Provide sufficient laboratory testing to establish the amount of lime and water required to stabilize the expansive soil.

 2. Specify the equipment and provide the method to ensure uniform mixing of the lime, soil and water. The lime treatment of soils is restricted to below 4 feet of final grade in landscaping and open areas. Also, specify the required mellowing period (to be confirmed during the test pad construction) prior to placement of the mixed material.

 3. Specify the necessary controls to protect the health of workers and neighbors and environmental controls to protect adjacent properties and water sources (i.e. ponds and streams) during construction.

 4. Specify the type and frequency of quality control testing to be conducted during the mixing and placement operation.

 5. Require the construction of a test pad with the required field testing to confirm the proposed methodology and mix design will produce results that comply with the approved Geotechnical Engineering Specifications.

Construction and Inspection

The County approved geotechnical engineering report must include the specifications for the use of lime for drying or stabilization. Prior to the lime operations commencing, the contractor is to meet with the Public Works Site Inspector to review the approved procedure. If conditions change during the course of the work and the contractor proposes to use alternative equipment or methods, an addendum to the Geotechnical Specification must be submitted to and approved by Public Works prior to commencing the work.

The Professional Engineer's Certification with all test results shall be submitted to the Department of Public Works. If the structural fill work sits "dormant" after certifications have been submitted and approved by the County, Public Works reserves the right to require a recertification when the weather or other events have adversely affected the structural fill prior to the commencement of work on the road or building pads.

Attachment:

Fairfax County Stabilization of Expansive Soils with Lime for Roads, dated October 20, 1989

CODE OF ORDINANCES
County of
PRINCE WILLIAM, VIRGINIA

Codified through
Ordinance No. 11-71, adopted December 13, 2011.
(Supp. No. 17)

CHAPTER 14 NOISE (*excerpts*)

Sec. 14-2. Violations of chapter.

Any person violating any provision of this chapter shall be guilty of a Class 2 misdemeanor (Ord. No. 89-143, 10-24-89)

Sec. 14-4. Maximum permissible sound levels generally.

(c) Any person, with lawfully obtained permits, who between the hours of 6:00 a.m. and 10:00 p.m. weekdays and between the hours of 9:00 a.m. and 10:00 p.m. on Saturdays, Sundays and legal holidays observed by county government operates or causes to be operated any equipment used in construction, repair, alteration or demolition work on buildings, structures, alleys or appurtenances thereto in the outdoors in any residential district within 100 yards of a lawfully occupied dwelling shall not be subject to the levels enumerated above.

(table omitted for this document)

(d) Persons performing construction of public projects, repair or maintenance work for such projects or persons performing work for private or public utilities for the repair of facilities or restoration of services shall not be subject to the levels enumerated above.

(Ord. No. 89-143, 10-24-89; Ord. No. 90-20, 2-6-90)



NOISE ORDINANCE EXEMPTION REQUEST APPLICATION

Date _____

Owner's Name _____ Phone _____

Address _____

Project Name and Location _____

I hereby request exemption of Section(s) and Subsection(s) _____ of Prince William County's **NOISE ORDINANCE** for the above-referenced project. I believe this exemption is justified based on the following information which I hereby certify as being correct:

Reason _____

I further understand that if determined necessary by the Director, this exemption may be revoked in accordance with Section 14-8, paragraph (3) of Prince William County's Noise Ordinance.

Signed _____ Print Name _____

Director's Action: Approved/Denied

Signed _____ Date _____
Name/Title

FOR COUNTY USE ONLY

Exemption Fee Required Yes [] No []
Exemption Fee Paid Yes [] No []

Amount _____ File # _____

If you feel you have been aggrieved by the decision of the Director, you may obtain review of such decision by the County Executive or his authorized agent by delivering a written statement of appeal to the Office of the County Executive within ten (10) days of the date of this decision.

- Cc: Police Chief
- Director of Public Works
- Director of Transportation
- Director of Development Services
- Environmental Services Division Chief
- Site Inspection Supervisor



COUNTY OF PRINCE WILLIAM

5 County Complex Ct. Suite 290, Prince William, VA 22192-5308
(703) 792-6820 Metro 631-1703 Fax 792-6828

Department of
Transportation

DCSM 604.01 H. All construction sites shall be provided with temporary signs acceptable to Public Works referencing the requirements of Section 14-4(c) of the Prince William County's Noise Ordinance. The signs shall be conspicuously posted in all construction sites and fully visible to all construction personnel. The signs should be bi-lingual (written in English and in Spanish). Adherence to this requirement shall be the responsibility of the developer(s) and/or contractor(s) and shall be monitored by the Department of Public Works. Violation of this sign posting requirement is a class II misdemeanor.

The temporary warning signs (one in English and one in Spanish), smaller than two square feet, shall be installed by the developer and/or contractor at each construction entrance of a project prior to the commencement of land disturbing activities. The signs shall read:

WARNING

**PRINCE WILLIAM COUNTY CODE PROHIBITS CONSTRUCTION WORK
MONDAY – FRIDAY: BEFORE 6:00 A.M. & AFTER 10:00 P.M.
WEEKENDS AND HOLIDAYS: BEFORE 9:00 A.M. & AFTER 10:00 P.M**

AVISO

**LA LEY DEL CONDADO DE PRINCE WILLIAM PROHIBE EL TRABAJO DE
CONSTRUCCION LUNES A VIERNES: ANTES DE LAS 6:00 A.M. Y DESPUES DE
LAS 10:00 P.M. SABADOS Y DOMINGOS Y DIAS FERIADOS : ANTES DE LAS
9:00 A.M. Y DESPUES DE LAS 10:00 P.M.**

The developer must maintain these signs in good condition during the active life of a project. These signs shall be removed at the recommendation of the Department of Public Works prior to final site acceptance and bond release inspection.

These signs shall be exempt from zoning approval or permit requirements.

CUT SHEET REQUIREMENTS
FOR
INSTALLATION OF DRAINAGE APPURTENANCES

DCSM 704.03 Cut Sheets

- A. After setting grade lines and stakes, the applicant's engineer or surveyor shall prepare suitable cut sheets in a clear and legible manner, giving necessary construction data.
- B. Two (2) sets of cut sheets, certified by a professional engineer or surveyor shall be submitted to the Department of Public Works. The engineer or surveyor who certifies the cut sheets shall also provide the following statement on both sets:

"The professional seal and signature appearing on this document certifies that information shown conforms to the approved plan and/or actual field conditions. Minor deviation from the approved plan shall be performed in a manner comparable to the original design and shall meet applicable standards."

The Department of Public Works may perform a cursory review to verify conformance to the approved plans.

- If any significant deviation is contemplated in location, line, or grade of any storm drain, masonry structure, or accessory from that shown on the plans approved by the Director, details of the proposed deviation shall be submitted to the Planning Office for review and approval before the changes are constructed.

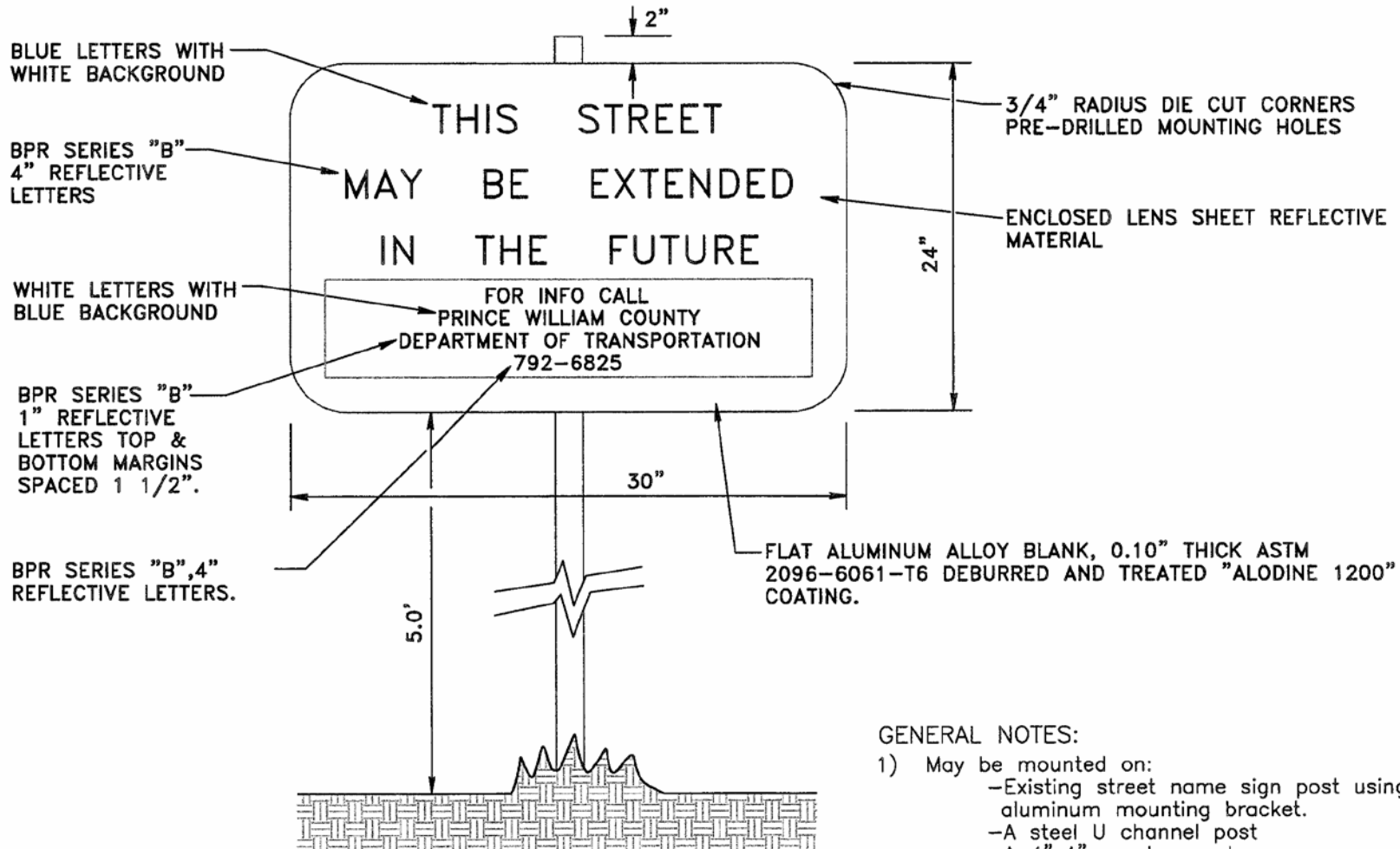

GENERAL NOTES:

- 1) May be mounted on:
 - Existing street name sign post using aluminum mounting bracket.
 - A steel U channel post
 - A 4"x4" wooden post

Detail No.	TSS-1		COUNTY OF PRINCE WILLIAM VIRGINIA	THRU STREET SIGN STANDARD	Rev. No.
650.47					Date 1/16/96 1/31/99

Prince William County Government Snow Removal Policy
For Active Site Development Projects

- The complaint is brought to the attention of the Department of Transportation (DOT) site inspector. He logs in citizen's name, address, and telephone number. He also provides his name and telephone number and requests citizen notify him immediately if the developer plows the snow.
- Site inspector tries to contact the developer using available telephone number(s). He notifies the developer to take appropriate action to make the streets safe for driving within 24 hours or 2:00 P.M. the following day, whichever occurs first. He also informs the developer, if the work is not done within the specified time period, the Department of Public Works (DPW) will perform the required work and the developer will be responsible for reimbursement of costs to the county within 10 working days.
- If attempts to contact the developer or their staff are unsuccessful, the site inspector leaves a detailed message as specified in the above paragraph on their answering machine.
- The site inspector logs the date and time when information was conveyed to the developer over the telephone or through their answering machine.
- The site inspector contacts Environmental Services Division (ESD) and alerts them of the possibility of snow plowing or other necessary action if the developer did not respond in timely fashion. The site inspector provides the name of the subdivision, street name(s), location, etc., to ESD, and approximate time when work may be done.
- The site inspector gets back to the citizen to inform them of the action taken so far and the time given to the developer for snow plowing. He provides his name and telephone number and requests citizen notify him immediately if the developer plows the snow.
- Next day, the site inspector verifies whether or not the developer has plowed the snow by the specified time.
- If the developer has plowed the snow, site inspector advises ESD that no further action is necessary. If snow has not been plowed, site inspector gives a notice to proceed to ESD staff and requests that invoice be sent to DOT after the snow has been plowed.
- DOT sends a copy of the invoice to the developer and requests reimbursement within 10 working days.
- If payment is not received within the specified time period, DOT advises developer that their requests for bond reduction, extension, occupancy, and/or street acceptance will not proceed until the reimbursement is made to the County.
- Upon receipt of reimbursement check from the developer, DOT forwards it to ESD for credit to their appropriate account.



COUNTY OF PRINCE WILLIAM

5 County Complex Court, Suite 170, Prince William, Virginia 22192
Phone (703) 792-7070 Fax (703) 792-7012

Checklist for Final Inspection and Bond/Escrow Release

1. Streets dedicated to public use (VDOT maintained streets) must be approved and accepted by VDOT prior to Final and release of Performance Bond by County. Contact Transportation Inspector for documentation requirements and scheduling with VDOT.
2. Perform self inspection to ensure all project items are in compliance before contacting the Site Inspector for final. Notify Home Owners Association (if applicable) of impending final inspection. Ensure all proffers have been met, this will be verified by County staff.
3. Site Inspector will provide instructions for submission of as-builts, record plats and Impervious Area Calculations for review by County staff. For commercial projects, (a) Storm Water Management maintenance agreement(s) must be filed (where required).
4. Schedule a final inspection with Site Inspector. Site inspection to include, but not limited to:
 - Inspection of all Storm Sewer and Storm Water Management systems. These systems need to be flushed and cleaned prior to inspection.
 - Inspection of all required landscaping, buffers, conservation area, etc. All plantings must be in place and alive prior to inspection.
 - Inspection of all common areas, slopes, etc. for adequate stabilization and vegetative cover significant enough to prevent erosion.
 - Inspection of concrete and asphalt by County with damaged areas marked for repair.
 - All street lights, signs and striping must be properly installed and functional.
 - All retaining walls and/or structures requiring special inspection by Critical Structures of Prince William County Department of Development Services need to be inspected and approved. Proof required.

Deficient items will be noted on a punch list, which is valid for ninety (90) days, after which an re-inspection of items will be scheduled. If ninety (90) days elapses and work has not been completed, the County reserves the right to re-inspect the entire site and generate a new punchlist.

5. All public water and sewer must to be finalized by the appropriate agency (Service Authority, Virginia American Water) prior to any final or bond release by Prince William County.
6. On receiving PWC final approval & recommendation of bond release, provide inspector with four (4) copies of the County approved, stamped as-built, and three (3) copies of the record plat. A final sign-off will be given to the developer and a copy sent to the Bond Administrator to facilitate the release of Performance Bonds.

Bonds will not be considered for release until all required sign-offs are received by the Bond Administrator.

Flowchart for Final Inspection and Bond/Escrow Release

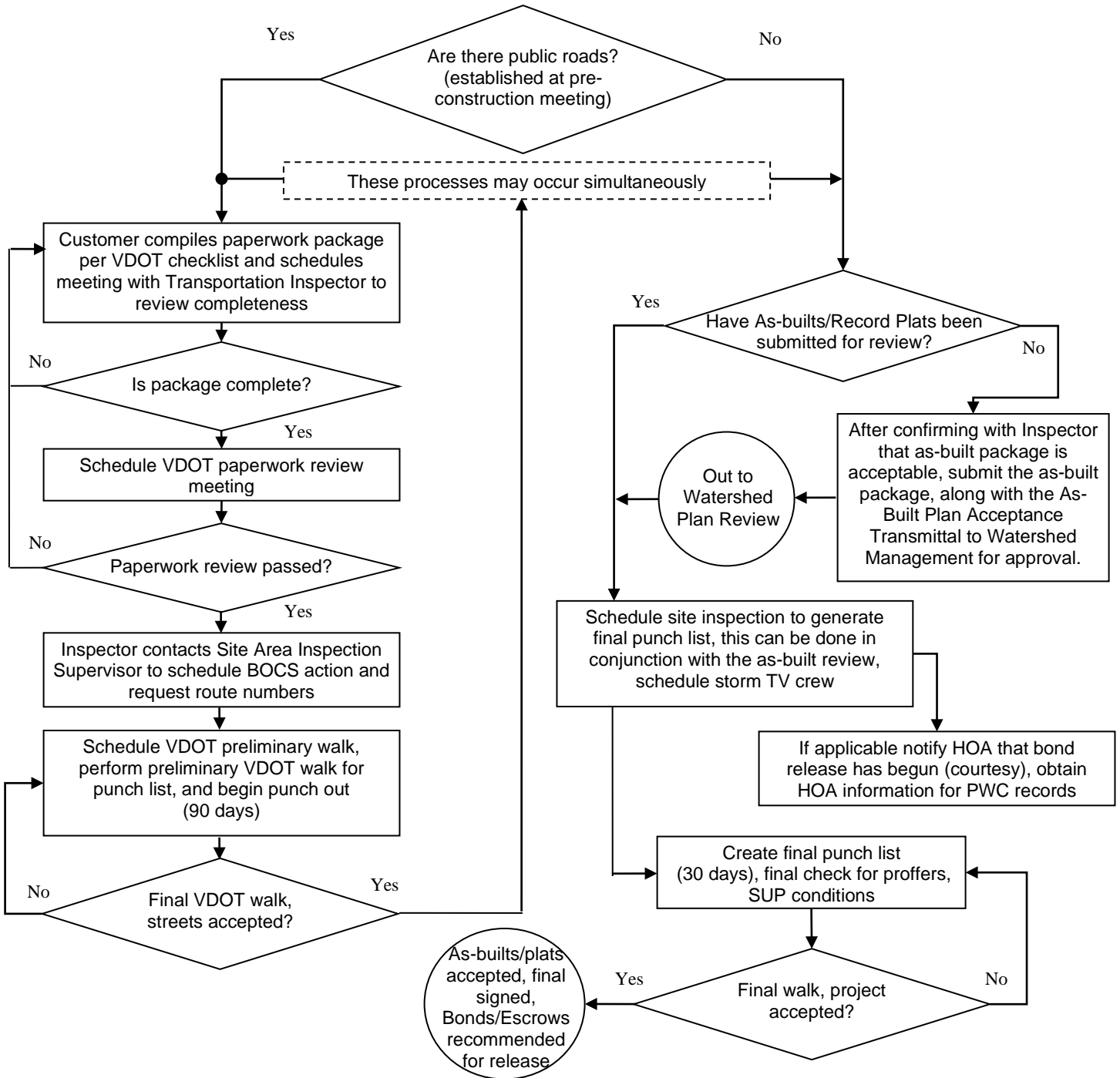



PRINCE WILLIAM COUNTY
Department of Development Services – Land Development Division

BOND AND ESCROW EXTENSION AND/OR REDUCTION
REQUEST INSTRUCTIONS

Intent and General Requirements:

The intent of these instructions is to provide the preparer of the extension and/or reduction request a better understanding of the policies and guidelines used by the County in processing, reviewing and calculating extension and reduction requests and to reduce confusion when requesting a reduction by providing the developer or their representative an opportunity to discuss with the site inspectors any discrepancies relating to the amounts and quantities used to determine a reduction of the performance bond or siltation erosion escrow.

Reduction and Extension requests must comply with Section 130.03.02 of the Design and Construction Standards Manual and Section 4.07 of the Administrative Procedures Section of the Design and Construction Standards Manual (DCSM).

Thirty percent (30%) of the bonded improvements must be completed before any bond reduction request will be processed [Section 4.07.4(2)]. Fifty percent (50%) must be completed for the first extension request and eighty-five percent (85%) for the second extension request [Section 4.07.3(D)(1)]. The County may accept up to three (3) reduction requests in any twelve month period. Requests for bond and escrow reductions will not be processed if there are unresolved site violations.

Siltation and erosion control escrows may be permitted a reduction(s) provided work has satisfactorily progressed to the stage where sufficient escrow remains to ensure the installation, maintenance, and performance of erosion and sediment control measures. The County may accept up to three (3) reduction requests in any twelve month period. Requests for bond and escrow reductions will not be processed if there are unresolved site violations. The maximum reduction(s) for the siltation and erosion control escrow cannot exceed seventy-five percent (75%) of the original amount.

Submission Requirements:

All extension and/or reduction requests must be submitted via e-mail at LDD@pwcgov.org or on a compact disc. The request must contain:

- A written explanation for the extension. The written explanation must include reasons and conditions which have precluded the completion of the required physical improvements.
- A written detailed time line to complete the project (what needs to be completed and anticipated date of completion). The request will be rejected if the time line fails to provide sufficient details on what needs to be completed and anticipated date of completion.
- A copy of the original Proffer Statement or Special Use Permit Conditions along with a current Proffer or Special Use Permit analysis must be submitted (if there is a rezoning or special use permit for the property). The analysis must display a current date and the information contained within the analysis must be up to date. The request may be rejected if any of the requested documents are not provided.
- Bond Extension and Reduction Estimate Worksheet must be completed. Bond reduction and extension requests do not require certification by a professional engineer. However, certified requests will be accepted for processing.
- The request must include name, address, telephone number and e-mail address for the developer and the preparer.

The filing fee for an extension and/or reduction request submitted prior to the agreement expiration date is \$1,267.78. The filing fee for an extension and/or reduction request submitted after the agreement expiration date is \$1,902.74.

Fees are required with the request, unless the request is submitted by e-mail. Fees for e-mail requests must be received within three (3) business days. The request will be rejected and the applicant will be required to resubmit the request if the fees are not submitted within (3) business days.

Bond Extension and Reduction Estimate Worksheet:

The form is in MSEXcel format and must be completed electronically by the preparer and submitted via e-mail or on a compact disc. The form requires the retention of a certain percentage of the construction for specific bonded items. The notes at the end of the form specify the required retention percentages. These are guidelines and the actual percentages monies held are determined by the inspectors and are based upon the level of quality of workmanship and materials. The preparer and/or applicant can meet with the inspectors to discuss any differences in the reduction amount. *The Bond Extension and Reduction Estimate Worksheet must be submitted in MSEXcel format. The worksheet can be downloaded from <http://www.pwcgov.org/LDDDocs>.*

Review Process:

Reduction requests are processed in accordance with the Bond Reduction Procedure. Once the extension and/or reduction request is reviewed and processed, the developer will receive a letter from the Department of Development Services. Projects that are considered for an extension and/or reduction will require proper documentation from the Surety Company or Financial Institution to officially extend and/or reduce the bond or escrow. Documentation from the Surety Company or Financial Institution must be submitted within thirty (30) days from the date of the Department of Development Services letter.

Documents from the Surety Company or Financial Institution cannot be accepted until the Department of Development Services has notified the developer that the extension and/or reduction request is under consideration. Documents received prior to this notification will be returned to the applicant.

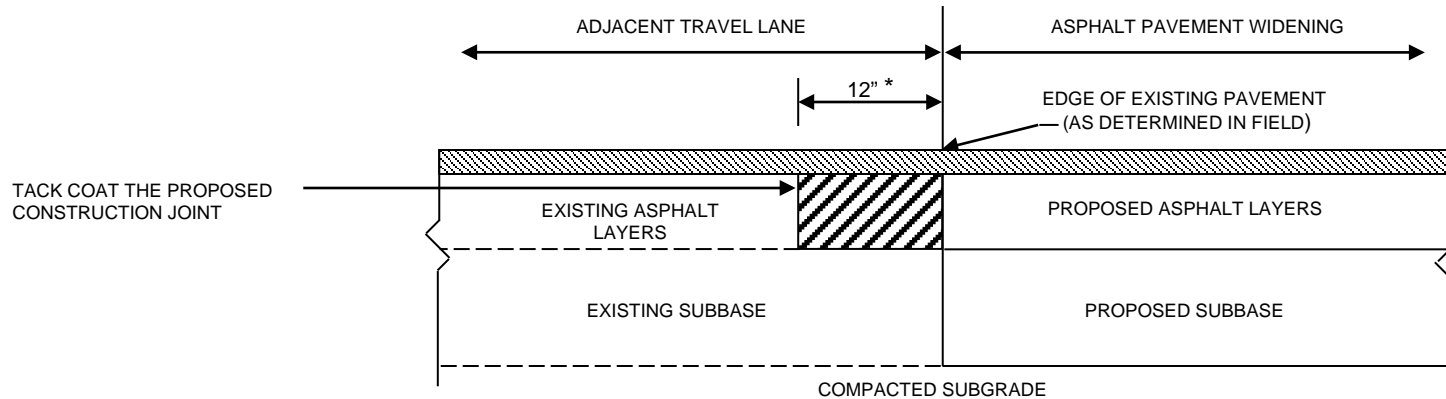

CONSTRUCTION JOINT DETAIL



Remove existing asphalt layers to existing subbase and replace with proposed asphalt widening layers.

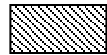

Proposed minimum 1 1/2 inch thick asphalt surface course (See Note 5).

*

Minimum 12 inches or greater as necessary to abut the full thickness of existing asphalt Layers as determined by cores (See Note 3).

NOTES:

- 1) Asphalt pavement widening shall have a pavement design in accordance with current VDOT procedures and be approved by the Engineer.
- 2) The pavement design for asphalt pavement widening shall meet or exceed the depths and types of the layers of existing pavement. Subsurface drainage of the existing and proposed pavement shall be addressed in the pavement design.
- 3) A minimum of three cores shall be taken along the center of the adjacent travel lane to determine the type and thickness of existing pavement layers. These cores shall be spaced no more than 500 feet apart.
- 4) The adjacent travel lane shall be milled a minimum depth of 1 1/2 inches and replaced with an asphalt surface course to match the proposed pavement widening surface course, unless waived by the Engineer.
- 5) The Engineer may require the milling depth of the existing pavement to be adjusted to achieve an acceptable pavement cross-slope and effective surface drainage.
- 6) Existing pavement markings and markers within the project limits shall be restored subject to the approval of the Engineer.
- 7) Final transverse pavement tie-in shall conform to the requirements of Section 315.05(c) of the specifications except that all joints at tie-in locations shall be tested using a 10-foot straightedge in accordance with the requirements of Section 315.07(a) of the latest VDOT Road and Bridge Specifications Manual.

Detail No.

650.56

APW-1



**COUNTY OF
PRINCE WILLIAM
VIRGINIA**

**ASPHALT PAVEMENT WIDENING
FOR WIDENING SUBJECT TO TRAFFIC**

Rev. No.

Date
8/8/08



COUNTY OF PRINCE WILLIAM

5 County Complex Court, Suite 120, Prince William, Virginia 22192-5308
(703) 792-6930 Metro 631-1703 Fax (703) 792-5285

DEPARTMENT OF
DEVELOPMENT
SERVICES

Wade A. Hugh
Director

October 17, 2011

TO: Development and Construction Industry

FROM: Wade A. Hugh *//Original signed//*
Director of Development Services

Nick Evers
Zoning Administrator

RE: Placement of Utilities

The County Zoning Ordinance, Section 32-250.71, requires all on site utility facilities {including water, sewer, power (transmission lines less than 34.5 KV), natural gas and telephone serving new uses} to be located underground. This Ordinance language, which has been in effect since 1991, does not apply to uses in the M-1 or M/T industrial districts or residential subdivisions of 2+ acre lots. The County Design and Construction Standards Manual, Section 125.01, also stipulates this requirement as referenced in the Zoning Ordinance.

We wanted to bring this criteria to your attention to improve the plan review process and to help you avoid unnecessary back-end costs associated with bringing your project into compliance. This standard is covered as part of the County pre-construction meeting, so please share this information with your staff.

If you have any questions, please do not hesitate to contact either one of us.

Nick Evers *//Original signed//*
Zoning Administrator
Nevers@pwcgov.org
703-792-6861

Wade Hugh
Director of Development Services
Whugh@pwcgov.org
703-792-6930

An Equal Opportunity Employer

DCSM 302.02 Fire Department Emergency Access in General:

A. All-weather access roadways to construction and demolition sites shall be provided during the time of the construction or demolition of a building. These requirements are not applicable to driveways serving single family dwellings. This access need not be paved or graveled, but must be able to meet the following criteria:

1. Such roadways shall be readily accessible to emergency and inspection staff vehicles.
2. Such roadways shall be capable of supporting a minimum of 76,000 pounds vehicular load, have a minimum clear width of 20 feet, a minimum vertical clearance of at least 13'6", a maximum vertical projection of 8", and be able to accommodate the turn characteristics of a 45' long truck.
3. Such access roadways shall not be blocked by vehicles, construction equipment, construction materials or anything else.

Virginia Statewide Fire Prevention Code, Chapter 14: Fire Safety During Construction and Demolition, Section 1412 Water Supply for Fire Protection:

1412.1 When required. An *approved* water supply for fire protection, either temporary or permanent, shall be made available as soon as combustible material arrives on the site.

Virginia Statewide Fire Prevention Code, Chapter 5: Fire Service Features, Section 505 Premises Identification:

505.1 Address identification. New and existing buildings shall have *approved* address numbers, building numbers or *approved* building identification placed in a position that is plainly legible and visible from the street or road fronting the property at all times. These numbers shall contrast with their background. Address numbers shall be Arabic numbers or alphabetical letters. Numbers shall be a minimum of 6 inches high with a minimum stroke width of 0.5 inch. Where access is by means of a private road and the building cannot be viewed from the *public way*, a monument, pole or other sign or means shall be used to identify the structure.

505.2 Street or road signs. Streets and roads shall be identified with *approved* signs. Temporary signs shall be installed at each street intersection when construction of new roadways allows passage by vehicles. Signs shall be of an *approved* size, weather resistant and be maintained until replaced by permanent signs.

Failure to provide appropriate address identification and/or street signs will be a violation of the DCSM and SFPC.

General Street Lighting Notes

The following pages contain miscellaneous requirements and general notes which are pertinent to the County's street lighting process. Please see the "Street Lighting Guide for Developers" for a full summary of the street lighting process.

The developer shall contact the Street Lighting Program Coordinator (SLPC) within 10 days of the preconstruction meeting to initiate the installation process. The street lighting process can be extensive and may take longer than six months to complete. Therefore, developers shall submit their project's Street Lighting Packet to the SLPC within 30 days of the pre-construction meeting. If revisions are made to the projects street lighting design the developer shall be responsible for submitting a revised Street Lighting Packet to the SLPC.

Developers are required by the County to install streetlights in all new residential developments which carry 400 vehicles per day (VPD) and in all commercial/industrial developments which carry 600 VPD in accordance with the Prince William County Design and Construction Standards Manual (DCSM) and the County Zoning Ordinance. Streetlight installation may also be governed by the developments Special Use Permit Conditions and Proffers.

An approved County site plan does not constitute an approved street lighting plan. The approved County plan will be checked by the SLPC for deficiencies pertaining to the DCSM street lighting requirements as well as the standards set forth by VDOT and the servicing power companies. The applicant will be notified if corrections to the submitted plans are necessary. All site plans will have a final review for street lighting requirements by the SLPC. If revisions are necessary, it shall be the sole responsibility of the developer/applicant to make the necessary changes to meet all the street lighting requirements set forth by the County, VDOT and the servicing power company. It is also the responsibility of the developer/applicant to contact the SLPC for corrections concerning street lighting requirements.

The developer shall submit to the SLPC a Street Lighting Packet to include a clear and legible copy of the most recent and up to date set of approved County site plan sheets pertinent to the street lighting for their project; with a plan cover sheet, plan pages that have been highlighted showing the proposed streetlight types and their locations as well as the unit price list/quantities sheet. Together with the plan sheets shall be a cover letter outlining the proposed number of streetlights, fixture type, wattage, project name, project address, Prince William County approved plan/file number, contact information for the developer (and or party responsible for billing), magisterial district and the name of the servicing power company. An electronic copy of the full plan set in PDF format shall also be submitted for the Counties electronic filing system. Incomplete packets shall be returned for correction and re-submittal.

If applicable, the developer will be responsible for providing copies of all Special Use Permit Conditions as well as all Proffers which pertain to street lighting for their proposed development.

It shall be the sole responsibility of the developer to make sure that the proposed streetlight designs are in accordance with the most current Prince William County Design and Construction Standards Manual (DCSM), and the Virginia Department of Transportation (VDOT) specifications and standards as well as any additional requirements set forth by the servicing power companies. If discrepancies are found within the street lighting submittal, the SLPC will issue a letter to the developer outlining the deficiencies which will need to be corrected before final approval is given. Once the appropriate corrections have been made, the developer shall submit a revised set of site plans to the SLPC for review and final approval. If the specifications and standards are met, then the SLPC will issue an authorization letter and preliminary design sketch to the servicing power company to obtain a cost estimate for the developments proposed street lighting.

The Developer will work directly with the servicing power company to accurately stake and install the proposed street lighting locations. It shall be the sole responsibility of the developer to confirm that the pole placements are correct and per Prince William County and VDOT specifications and standards. If relocation of the lights within the project is required to meet set standards subsequent to installation, the developer shall be responsible for all expenses incurred by the servicing power company. The developer shall also be responsible for the cost of any required easements if relocation is necessary.

Waivers to the DCSM criteria for street lighting are reviewed on a case-by-case basis. It is the responsibility of the applicant to fill out and submit the DCSM Waiver Form. The applicant shall also be responsible for all costs associated with the processing of the waiver and of any required plan revisions.

The developer is responsible for granting utility easements and financing the cost of all construction related to the installation of streetlights for their development. Upon final inspection and approval by the County the servicing electric power company will then be authorized to add the projects streetlights monthly service and yearly maintenance costs to the County's street lighting account.

The developer shall have the "Acknowledgement of Streetlight Installations Form" signed by the prospective property owners and notarized if the required streetlights have not been installed by the servicing power company prior to the request for occupancy. If the proposed streetlights are on the property line, then the developer shall be responsible for obtaining the signatures of both property owners. This form will be required for final lot grading inspection. Per section 601.09 of the DCSM occupancy will not be granted and developers will not be released from bond unless the "Acknowledgement of Streetlight Installations Form" is signed, notarized, and the developer possesses a paid receipt for the developments streetlights from the servicing power company.

The developer will be responsible for all costs of streetlight construction, including easement acquisitions if necessary. The servicing power company will inform the developer of any modifications or field adjustments that are needed to the streetlights shown on the approved plans that may be required to comply with current Virginia Department of Transportation specifications and standards.

Street lighting cost estimates from the servicing power company are good for 90 days. If the cost is not paid within that timeframe, then the project will have to be recalculated. Should conditions exist beyond levels included in the cost estimate (Such as the need for rock excavation, blasting, excessive trenching/boring or the presence of hazardous materials, etc.) which may substantially change the magnitude of the project, the servicing power company reserves the right to halt construction and submit a revised cost estimate. Also, the project cannot be released to their construction department until full payment has been made by the developer.

When a developer is requesting a change and or pole relocation on a plan after it has been approved by the Planning Department, a field revision may be granted by the Street Lighting Program Coordinator (SLPC) without the developer having to resubmit a revised site plan through the Planning Department. This shall be done only if all specifications and standards are met. The developer will submit in writing, as well as a revised plan showing the proposed changes. Once the letter and plans have been reviewed and approved by the SLPC then a field revision approval letter will be issued to the developer by the SLPC. However, if the proposed revisions will require an easement then the developer will have to submit a revised plan through the Planning Department for approval (This is required due to the fact that all easements are recorded within the Planning Department).

From receipt of the developer's Street Lighting Packet the SLPC shall have 45 days to review the developers Street Lighting Packet and confirm that the proposed street lighting is acceptable per the County's DCSM, Special Use Permit Conditions and Proffers as well as VDOT's standards.

If discrepancies are found within the site plan, the developer shall be responsible for making the appropriate changes and resubmitting a revised Street Lighting Packet. From receipt of the revised packet the SLPC shall have an additional 14 days to complete the review process. If a DCSM Waiver is requested, upon receipt of the processed waiver the SLPC shall have 14 days to complete the review.

If a DSCM Waiver is requested and either Special Use Permit Conditions or Proffers exist pertaining to street lighting for the proposed development it may be denied. Special Use Permit Conditions and Proffers would preside over Waivers. In these situations, they will be reviewed on a case-by-case basis.

The servicing power company will not release jobs for construction until the developer/applicant has made full payment for their projects street lighting and the developer has finalized all their cable runs and grading is within six inches of final grade.

Special Notes:

It shall be the sole responsibility of the developer to confirm that the pole placements are correct and meet all current Prince William County, and Virginia Department of Transportation and the servicing power companies' specifications and standards. If relocation of the lights within the project is required to meet current standards subsequent to installation, the developer will be responsible for all expenses incurred by the servicing power company. The developer shall also be responsible for the cost of any required easements or permits if relocation is necessary.

Poles which are set within utility strips (in front of a sidewalk or paved trail), clear zone or the right of way (without County & VDOT permits), whether they are shown in those locations on the approved site plan or not shall be the responsibility of the developer to relocate.

It shall be the sole responsibility of the developer to have all private utilities marked. These may include but are not limited to the following; sprinkler systems, invisible fencing or phone and water lines. It is the developer's responsibility to mark any private facilities that may be damaged during the streetlight construction. The servicing power company or the County will not be responsible for damage to private facilities if their location is not clearly marked in the field.

The developer's bond money will be used to correct any deficiencies pertaining to the projects street lighting plan. Occupancy permits will not be granted and the bond money will not be released until all current standards and specifications have been met.

Occupancy Inspections for Street Lighting:

Prior to the issuance of occupancy permits, the streetlights should be installed as per approved plans at the street intersections, cul-de-sacs, and in the general vicinity of the houses to be occupied. However, if street lights have not been installed due to servicing Power Company's scheduling procedures, the following two documents must be submitted to the County inspector conducting the occupancy inspections:

1. A paid receipt from the servicing power company, at least 30 days prior to the occupancy request. This will indicate that the developer has paid the necessary fees allowing the servicing power company sufficient time to install the required street lights.
2. A fully executed Statement of "Acknowledgement of Streetlight Installations Form" signed by the future property owners at closing.

Whenever possible, the site inspectors should remind the developers/ superintendents that in order to avoid delays, the street lights should be installed well ahead of the planned occupancy inspection requests to the County.

Memo:

The Street Lighting Branch requires that an "Acknowledgement of Streetlight Installations Form" be signed and submitted by the builder or developer from the homeowner(s) in the immediate vicinity of the proposed streetlight location requesting occupancy. This requirement will remain in effect until the servicing power company completes all the streetlight installations included with the performance bond.

You may contact the Prince William County Street Lighting Program Coordinator at the following address if you have any questions or comments. Also, please submit all Street Lighting Packet's to the address below.

**Allen Hedgepeth
Street Lighting Program Coordinator
Prince William County
Department of Transportation
5 County Complex Court, Suite 290
Prince William, Virginia 22192**

**Phone: 703-792-6823
Email: ahedgepeth@pwcgov.org**

These notes do not preclude any authority of the Design and Construction Standards Manual, Zoning Ordinance, Uniform Building Code, Special Use Permit Conditions, Proffers or VDOT specifications and standards. Should there be any questions, please contact the Planning Department at (703) 792-6830 or the Street Lighting Program Coordinator at (703) 792-6823.



PRINCE WILLIAM COUNTY
DEPARTMENT OF TRANSPORTATION
5 County Complex Ct. Suite 290
Prince William, VA 22192
703-792-6825

Effective Date
2/4/2019

STREET LIGHTING AGREEMENT

The Prince William County Preconstruction Package Minimum Inspection Program Item #11 states streetlights shall be installed as shown on the approved plans or as amended by the Street Lighting Program Coordinator (SLPC) to meet County and State standards prior to issuance of occupancy.

The developer shall contact the SLPC within ten (10) business days after the preconstruction meeting to initiate the installation process. This process is extensive and may cause delay in obtaining occupancy.

By signing below, I agree that I am fully cognizant of all street lighting requirements associated with the Preconstruction Package.

Developer's Representative:

Project: _____ Plan #: _____
Owner's Rep (Print): _____ Signature: _____
Title: _____ Date: _____

(It shall be the sole responsibility of the Developer's Representative to forward document to the Owner for review, signature & Notarize)

Owner:

Project: _____ Plan #: _____
Owner (Print): _____ Signature: _____
Title: _____ Date: _____

Notary:

This agreement shall be signed and notarized by the owner, and given to the Site Inspector within ten (10) business days after the preconstruction meeting.

STATE OF _____

COUNTY OF _____, to-wit:

I, the undersigned, a Notary Public in and for the jurisdiction aforesaid, do hereby certify that

_____, whose name is signed to the foregoing Street Lighting Agreement, has personally acknowledged the same before me in my aforesaid jurisdiction.

Given under my hand and seal this ____ day of _____, 2019.

My commission expires:

Notary Public

Registration No.: _____

*Per Section 601.09 – Street Lights, Paragraph E of the PWC DCSM, prior to issuance of occupancy permits for lots in the vicinity of the roadway luminaires, the luminaires shall be installed, as per the approved plans.

PRINCE WILLIAM COUNTY
Design and Construction Standards Manual
General Requirements for Occupancy

601.09 E. Prior to the issuance of occupancy permits for lots in the vicinity of the roadway luminaires, the luminaires shall be installed, as per the approved plans. If the installations are delayed due to the utility company's scheduling procedures, a County-approved form, "Acknowledgement of Street Lights Installation" must be completed by the contract purchasers. The completed form and a paid receipt from the utility company shall be submitted to the site inspector before occupancy is granted.

602.07 R. Pedestrian accessible ramps in accordance with IIM-LD-55 shall be provided at all curbed intersections, even when sidewalks and trails are not present and shall be constructed in accordance with VDOT standards, or ADAAG (American with Disability Act Accessibility Guidelines) whichever is more restrictive.

602.11 H. For staged construction, two and one-half (2-1/2) inches shall be the maximum thickness of the bituminous concrete surface (SM-9.5A or SM-9.5D). The thickness of each lift shall be of one and one quarter (1-1/4 inches).

602.11 I. If staged construction is performed, a four (4) foot radius area, measured from the center of the manhole cover around protruding utility manholes, shall be paved with leveling asphalt concrete surface mix (SM-9.5A) to provide a relatively smooth riding surface. In addition, the asphalt concrete paved peripheries shall be painted with twelve (12) inch wide white colored paint acceptable to County inspectors. The maximum exposure limit for staged construction shall be two (2) years, unless it is extended by the Director of Transportation.

602.12 G. Guardrails shown on the approved plan shall be installed after the asphalt base course of the roadways is in place and/or prior to the issuance of occupancy permit for uses within the development.

602.18 E. No occupancy permit shall be issued until all sidewalks and/or trails, in the general area of the units scheduled for occupancy, have been constructed, inspected, and approved.

603.15 B. The plans shall provide the following note: "A joint inspection will be held with the developer and representatives of the County and VDOT to determine if and where guardrails will be needed. The developer shall be responsible for providing guardrails as determined by this joint inspection." The guardrails shall be installed per VDOT standards prior to granting the first occupancy in each section, in which streets are constructed and the guardrails are determined necessary.

604.01 F. No occupancy permit will be issued to dwelling unit(s) unless the frontage improvements and all roadways within the specific phase including the main entrance are paved. Full pavement depth, with the exception of the final top coat, is acceptable provided it is agreed to by Public Works.

604.04 E. Street name signs and stop signs shall be posted at all street intersections, and at all entrances to parking bays for residential development. Temporary street signs must be posted before the use of vehicular traffic, inclusive of construction vehicles. Permanent street signs and stop signs must be posted prior to the occupancy of any house or unit being served by the street.

604.06 A. Street name signs shall be installed at all street intersections in accordance with Details 650.45 and 650.46 of this manual.

610.06 D. Before occupancy of any single-family attached unit, the parking spaces assigned to the particular unit should be demarcated or marked (labeled) on the curb.

610.06 H. The cost of luminaires shall be bonded with the County during the site plan approval. The luminaires shall be installed prior to occupancy of any unit in which the luminaires service. Deviation from this requirement, due to utility company policies, will be reviewed and approved on a case-by-case basis by the director of Transportation.

610.08 Handicapped Parking:

A. Handicapped parking and building or sidewalk accessibility shall be provided in accordance with the current edition of the Virginia Uniform Statewide Building Code (VUSBC).

B. Handicapped parking spaces shall be identified by above grade signs and demarcated in accordance with Details 650.50 and 650.51 of this manual and ADAAG (Americans with Disabilities Act Accessibility Guidelines) standards.

C. Handicapped parking spaces shall be located as close as possible to a main building Entrance ramp or walkway. However, the director of Transportation may require some spaces at alternate locations to provide greater accessibility for the entire development. A combination of ramps, walkways, crosswalks or curb ramps shall be required in conjunction with those spaces.

D. Where curb exists between the parking lot and sidewalk, an inclined approach shall be provided to allow convenient access for wheelchairs. Built-up curb ramps shall be located so that they do not project into vehicular traffic lanes. This approach shall have a slope of not more than one (1) foot in twelve (12) feet and be three (3) feet wide, exclusive of flare sides. Inclined approaches shall be provided and arranged to allow convenient access to a building entrance and from one (1) curb area to another. Such approaches shall be provided at intervals not exceeding one hundred (100) feet.

E. A request for modification of any of the requirements of this section must be submitted in writing to the director of Transportation.

710.05 A. An approved grading plan and permit shall be required to be on the job site during construction. The approved grading plan is used to check the final grading prior to the issuance of the occupancy permit. The occupancy permit may be denied if the grading plan and the actual grading of the site do not substantially agree.

710.06 F. No occupancy permit shall be issued until all retaining walls in the general area of the units scheduled for occupancy have been constructed, inspected and approved.

711.04 A. Subdivision Lighting: On each single-family detached residential building lot within a subdivision, where the minimum required lot area is twenty thousand (20,000) square feet or less including lots with no minimum area requirements, the subdivider shall install a yard light on each lot which conforms to the design standards of this manual (See Exhibit 21). All required yard lights shall be installed prior to occupancy.



Thomas Blaser
Director

REQUIRED ITEMS PRIOR TO OPENING OF NEW ROAD TO GENERAL PUBLIC

- Correction of any violation items
- Density testing records up-to-date
- Storm Sewer Inspection
- VDOT approval of large (>36 sf) storm drainage structures
- Base pavement
- Traffic Control Signs
- Street Signs
- Guardrail (if necessary)
- Pavement Striping (if necessary)
- Snow caps around manholes (if not topped)
- Removal of all dumpsters, portable toilets and construction material from the right-of-way
- Street Lights (when required)
- Traffic Control Signals (when required)
- Notification to BOCS Board Member
- Other (Concerns relevant to a specific project)



Policy for Concrete Re-Inspection Fees and Roadway Open Cut Trenching Fees

- Concrete Re-Inspection Fee:

The Department of Transportation (DOT) area inspector shall require a re-inspection fee for any inspection of driveway aprons and sidewalks where the work is deemed not ready or incomplete when the contractor has requested an inspection. The DOT Inspector will issue the concrete re-inspection form requiring a re-inspection fee of \$145.60 to be paid prior to scheduling the re-inspection. At the time of the re-inspection, the responsible party will need to provide the DOT Inspector with the paid receipt. Failure to pay the re-inspection fee, provide the paid receipt and/or failure to notify the DOT inspector shall result in a Notice of Violation until corrected.

- Open Cut Trenching Fee:

Open Cut Trenching of any travel ways and streets to be maintained by the County, State or HOA, which are not in the State Highway System requires a fee of \$205.80 for each open cut. This fee shall be paid prior to performing any open cut(s). The DOT area inspector shall be notified 48 hours prior to any open cutting of any paved surface. Failure to notify the DOT inspector and/or failure to pay the fee may result in a Notice of Violation until corrected and may require a warranty bond to be posted for 5 years from the time of bond release.

- Concrete Re-Inspection and Open Cut Trenching Fees are to be paid at:

Department of Development Services Land Development Division – Land Counter
5 County Complex Court, Suite 180
Prince William County, VA 22192

- Notice of Violation:

If a Notice of Violation is issued - DCSM 130.03.02 - Reduction requests shall not be approved if the performance agreement is in default or if the site is in violation.

- Warranty Bond:

If the violation is determined by the County and VDOT to be minor (the future safety and integrity of the roadway and its appurtenances is not considered at risk), the developer will be required to post a three (3) year warranty bond with the County. The amount of the warranty bond will be determined according to VDOT and the County. If the developer does not obtain a warranty bond, VDOT will not accept the street into the State Secondary System. If the violation is determined by the County and VDOT to be major (the future safety and integrity of the roadway and its appurtenances is considered at risk), the developer's entire road construction bond for the street in question or ten percent of the total construction bond for the development (whichever is greater) will be held by the County for five years to insure the future safety and integrity of the street. A copy of the violation will be sent to the developer's bonding/surety company.



COUNTY OF PRINCE WILLIAM DEPARTMENT OF TRANSPORTATION

5 County Complex Ct. Suite 290
Prince William County, VA 22192

Department of
Transportation

Effective Date:
January 23, 2020

Concrete Re-Inspection and Roadway Open Cut Trenching Fees

Fees must be paid at: Department of Development Services Land Development Division – Land Counter
5 County Complex Court, Suite 180 Prince William, VA 22192 703-792-6830

• Concrete Re-Inspection Fee:

Any inspection of driveway aprons and sidewalks where the work is deemed not ready or incomplete, the Department of Transportation Area Inspector will require a re-inspection fee of **\$145.60 per lot**. At the time of the re-inspection, the responsible party shall provide the Department of Transportation Area Inspector with the paid receipt.

Re-Inspection Required

Inspection Date: _____ Project: _____ Plan #: _____ Lots: _____

• Open Cut Trenching Fee:

Open Cut Trenching of any paved surface, travel ways and streets which are not in the State Highway System requires a fee of **\$205.80 for each open cut**. This fee shall be paid prior to performing any open cut(s). The Department of Transportation Area Inspector shall be notified 48 hours prior to any open cutting of any paved surface. Failure to notify the Department of Transportation Area Inspector and/or failure to pay the fee shall result in a Notice of Violation until corrected and may require a warranty bond to be posted for up to 5 years from the time of bond release.

Date: _____ Inspection Area: _____ Project: _____ Plan #: _____

1.	Utility:	Location:	
2.	Utility:	Location:	
3.	Utility:	Location:	
4.	Utility:	Location:	
5.	Utility:	Location:	
6.	Utility:	Location:	
7.	Utility:	Location:	
8.	Utility:	Location:	
9.	Utility:	Location:	
10.	Utility:	Location:	
11.	Utility:	Location:	
12.	Utility:	Location:	
13.	Utility:	Location:	
14.	Utility:	Location:	
15.	Utility:	Location:	
	← TOTAL NUMBER OF OPEN CUT TRENCHES		TOTAL FEE:

APPLICANT

COMPANY

CONTACT PHONE NUMBER

Guidelines for phasing of a townhouse/condo development or commercial/industrial site for occupancy purposes:

1. Unless a multi-family residential or multi-tenant commercial/industrial project can be built and occupied as a complete, contiguous unit, an occupancy phasing plan must be completed by the developer and approved by the site inspector; there is an associated cost per approved phase.
2. If an occupancy phasing plan is required, no occupancy inspections will be scheduled without an approved occupancy phasing plan. There is an occupancy inspection fee per phase.
3. A minimum of five (5) occupancy plans must be submitted for approval, such plans will be stamped as approved, and signed and dated by the site inspector. One copy must be available on site for any occupancy inspection.
4. A residential phase may not have less than one townhouse row or building unit.
5. The first phase should include frontage improvements including street lights, sidewalks, traffic control signs, stormwater management pond(s), etc., subsequent phases must include safe ingress and egress of emergency vehicles, landscaping, signage, striping, etc.
6. The last phase should contain approximately 25% of the total number of units.
7. If, after approval, it is absolutely necessary for a builder to split a phase which has at least two rows or blocks of residential units, or two commercial/industrial units, the phasing plan should be revised and a new review fee required for all phases that have not been approved for occupancy.
8. During the final phase inspection, the entire site should be inspected to ensure completion of all non-bonded items. If any of the non-bonded items are not complete at this time, the site inspector will prepare a punch list of deficiencies. A cash escrow must be posted with the Bond Administrator prior to issuance of the final occupancy as a guarantee that this work will be done diligently.
9. The site work for the entire phase should be inspected for compliance to the approved plans.



**COUNTY OF PRINCE WILLIAM
DEPARTMENT OF PUBLIC WORKS**

Environmental Services Division, Watershed Management Branch
5 County Complex Court, Suite 170, Prince William, Virginia 22192
Main (703) 792-7070 Fax (703) 792-6297

OCCUPANCY PHASING PLAN FEE VERIFICATION

Staff Use Only

ILP # _____

Amount received (@ **\$99.71/per phase**): \$ _____

Received By: _____

RCPT _____

Received / Emailed Date: _____

PART A: APPLICANT

LND NUMBER: _____

Number of Phases Requested: _____

PROJECT NAME/ SECTION / PHASE: _____

CONTACT PERSON: _____

EMAIL: _____

ADDRESS: _____

TELEPHONE NUMBER: _____

PART B: DEPT. OF PUBLIC WORKS / DEPT. OF TRANSPORTATION USE ONLY

I have reviewed the occupancy phasing plans for the referenced project. These plans will be approved upon verification that the appropriate fees have been paid as follows:

The number of phases approved/revised is: _____ @ **\$99.71/per phase.**

Site Inspector Name/ Signature

Date



**COUNTY OF PRINCE WILLIAM
DEPARTMENT OF PUBLIC WORKS**

Environmental Services Division, Watershed Management Branch
5 County Complex Court, Suite 170, Prince William, Virginia 22192
Main (703) 792-7070 Facsimile (703) 792-6297

OCCUPANCY SITE INSPECTION REQUEST

Staff Use Only

ILP # _____ Amount received (@ **\$141.75/per bldg.**): _____
Received By: _____ RCPT: _____
Received/Emailed Date: _____ Site Inspection Area _____

LND NUMBER: _____ OCCUPANCY SECTION / PHASE** _____

***One per building*

PROJECT NAME*: _____

**Note: Use formal project name as shown on County-approved plan.*

Site or Subdivision Plan Number: _____

Site Address (es): _____

Building Permit Number(s): _____

Lot or Building Number(s): _____

ONE OF THE FOLLOWING BOXES MUST BE CHECKED TO SCHEDULE A SITE INSPECTION:

- Site Occupancy Inspection Request (**Impervious Area Certification Required On Site**)
OR
 A phased site plan has been approved for this project

COMPANY NAME: _____

CONTACT PERSON: _____

EMAIL: _____

ADDRESS: _____

TELEPHONE NUMBER: _____

It is understood that the requested site inspection will be conducted within five (5) working days, weather permitting. It is further understood that a Certificate of Use and Occupancy will be issued only when either all outstanding items have been completed or the developer has provided assurance (cash escrow or irrevocable letter of credit) in an amount sufficient to complete the unfinished work as described on the site inspection report punch list items.

SIGNATURE: _____

Check List for Street Acceptance Paper Review in Prince William County

PROJECT: _____

- ___ 1. **Construction Plan** – (1) full size copy of the approved construction plan.
- ___ 2. **Record Plats** – (1) full-scale copy for VDOT Permits, (1) copy reduced to 11”x 17” for VDOT Central Office. All plats must be recorded and show the deed book, page number and date, or the instrument number. Include electronic disc with PDF copy of all recorded plats.
- ___ 3. **Composite Sketch** – ONLY NECESSARY when overall street layout for current section cannot be easily understood from record plat. TBD by VDOT and/or the County, (2) copies will be required.
- ___ 4. **Legal Instruments** – subdivision deed, quitclaim deeds and/or Subordination of Rights Agreement, vacated easements, turn-around easements, etc. All documents must be recorded and show the deed book, page number and date, or the instrument number.
- ___ 5. **As-built Plans** – Provide a compact disk containing as-built plans in PDF format with each plan sheet in a separate file with the subdivision name, page number in the file name.
- ___ 6. **Storm Sewer TV** – All punch list items have been satisfied and verified by PWC DOT inspector prior to VDOT preliminary walk. Valid for one (1) year. Date of TV: _____
- ___ 7. **Project Data Sheet - Prince William County** – complete Subdivision Name, Developer Name, Design Engineer, and Contractor Information.
- ___ 8. **Segment Data Sheet - Prince William County** - A separate form needs to be completed for each line item on the draft resolution.
- ___ 9. **Approved Pavement Design** – provide a copy of the Pavement Re-Design Approval letter from Prince William County indicating the approved pavement design for each street.
- ___ 10. **Draft Resolution** – (1) copy of the Board of Supervisors’ draft resolution. Include approved resolution if available.
- ___ 11. **Approval letter from Bridge Section** for Drainage Structures with an opening > **36 SF**.
- ___ 12. **Land Use Permit Applications/Utilities (LUP-IPP)** – Provide two (2) copies of the signed Land Use Permit – In Place Permit application needs to be submitted for each utility company with facilities in the right-of-way. Provide two (2) copies of the sketch/plan showing the location of the facilities with each application.
- ___ 13. **Land Use Permit Applications / P.W.C.** – Applications submitted from P.W.C. for landscaping, sidewalks not maintained by VDOT, etc. Applications must include (2) copies of plans. Landscaping plans must be pre-approved by V.D.O.T.

- __14. **Land Use Permit Applications / H.O.A.** – Applications submitted from the developer or H.O.A. for irrigation systems. Applications must include (2) copies of plans that have been pre-approved by V.D.O.T. A continuous bond and permit are required at the time of final inspection and paperwork submittal.

- __15. **Speed study** – Speed study certified by professional engineer shall be submitted for VDOT approval prior to the street acceptance for any road to be posted other than the statutory speed limit.

- __16. **Miscellaneous** – Agreements for extrinsic structures (dams, tunnels, etc.), VDOT snow removal access, ornamental street signs, speed studies, school signs. Pavement marking plans, SSAR waivers, warranty bond etc.

Note: If an item is not required, indicate N/A in the appropriate check box.
See Paper Review Checklist SUPPLEMENT for further explanation of paperwork.

PWC Inspector: _____ *Developer Rep:* _____

Assembly Requirements for VDOT Street Acceptance Paperwork Review
(SUPPLEMENT to Check List for Street Acceptance Paper Review in Prince William County)

PLEASE ARRANGE PAPERWORK IN ENVELOPES AS FOLLOWS:

ENVELOPE #1 *(Please write project name and contents on envelope):*

- (Item 1) One full size set of the approved **Construction Plans** can be kept separate.
- (Item 2) Reduced 11" x 17" **PLAT** shall be folded and placed in Envelope #1. Full size plats can be kept separate or folded and placed in envelope.
- (Item 3) **Composite Sketch** (if necessary) may be any convenient size and scale, and shall be placed in Envelope #1. *When in doubt, provide a composite sketch.*

ENVELOPE #2 *(Please write project name and contents on envelope):*

- (Item 4) **Legal Instruments** (subdivision deed, quit claim deeds and/or Subordination of Rights Agreement, turn-around easements, etc.) shall be placed in Envelope #2.

ENVELOPE #3 *(Please write project name and contents on envelope):*

- (Item 5) **As-built** plan on compact disk shall be placed in Envelope #3. An as-built hardcopy is sometimes helpful, but is not required.
- (Items 7 & 8) **Project Data Sheet – Prince William County** needs to be filled out with the subdivision information, and developer, design engineer and contractor name and address information. **Segment Data Sheets – Prince William County** need to be provided for each line item on the draft resolution.
- (Item 9) **Approved Pavement Design** letter(s) from Prince William County indicating the pavement design for each street within the package.
- (Item 10) **Draft Resolution** shall be placed in Envelope #3.
- (Item 11) **Inspection Report from VDOT Bridge Section** for drainage structures or tunnels with an opening greater than 36 ft².

ENVELOPE #4 *(Please write project name and contents on envelope):*

- (Item 12) Submit the current version (see link below)* of the **LUP-IPP** (in place permit application for subdivision street utility) for Land Use Permits. These permits shall be combined into Envelope #4. EACH utility company shall be written on envelope. Termini must match those listed on the Draft Resolution. Plan/sketch needs to be attached to LUP-IPP's showing the location of the facilities.
- (Items 13 & 14) Submit the current version (see link below)* of the **LUP-A** (landscaping, irrigation permits, etc.) for all Land Use Permits that require a fee and/or a bond to the Manassas Permits Office Manager. Plans are to be included.
- (Item 15) Submit **maintenance agreement** (agreements for extrinsic structures, golf cart tunnels, concrete driveways in ditch sections, VDOT snow removal access, ornamental signs, etc.) shall be placed in envelope and labeled.

* NOTE: Current version of permit applications may be found on VDOT website:
<http://www.virginiadot.org/business/bu-landUsePermits.asp>

Project Data Sheet - Prince William County

One copy of this form is to be filled out for each subdivision, and will be submitted with the items listed on the *Check List for Street Acceptance Paper Review in Prince William County*.

Subdivision Name:			
Plan approval date:			
Subdivision Manual used for plan approval:	2005 SSR	2009 SSAR	2011 SSAR
SSAR Waiver	Yes	No	
Proposed or actual Resolution date:			

Developer Name:			
Address:			
Phone #:		Fax#:	
Contact Person:			
Email address:			

Design Engineer:			
Address:			
Phone #:		Fax#:	
Contact Person:			
Email address:			

Contractor:			
Address:			
Phone #:		Fax#:	
Contact Person:			
Email address:			

***** Complete a separate Segment Data Sheet - Prince William County form (attached) for each line item on the draft resolution.**

Segment Data Sheet - Prince William County

One *Segment Data Sheet* needs to be completed for each line item on the draft resolution, and all of the *Segment Data Sheet(s)* will be combined with one *Project Data Sheet*.

Subdivision Name:			
Street Name:			
Route Number:			
From:			
To:			
Mileage Length:			
Public Service:	3+ Occupied Dwellings / Connecting Link / Other		
Pavement Design:	Surface:	Intermediate:	Base:
Right-of-Way Width:	Min. width:		Max. width:
Instrument Number(s):			Record Date:

ROADWAY INVENTORY DATA

Travel Surface Width in feet:	*		
Pavement Width in feet:	*		
Roadway Shoulder Width in feet:	Left:		Right:
Initial Number of Through Lanes:			
Ultimate Number of Through Lanes:			
Curb & Gutter:	Left:	YES / NO	Right: YES / NO
Sidewalk:	Left:	YES / NO	Right: YES / NO
Shared Use Path/Trail:	Left:	YES / NO	Right: YES / NO
Median Shoulder Width in feet:	Left:		Right:
Median Width in feet:	Minimum		Maximum
Median Type:	**		
Drainage Structure > 36 SF:	YES / NO	Number:	

* See attached Travel Surface and Pavement Widths Diagram to determine widths.

** For example: curbed grass, concrete, depressed, etc.

For VDOT Use Only: _____ DACHS Entry _____ RIMS Entry
--

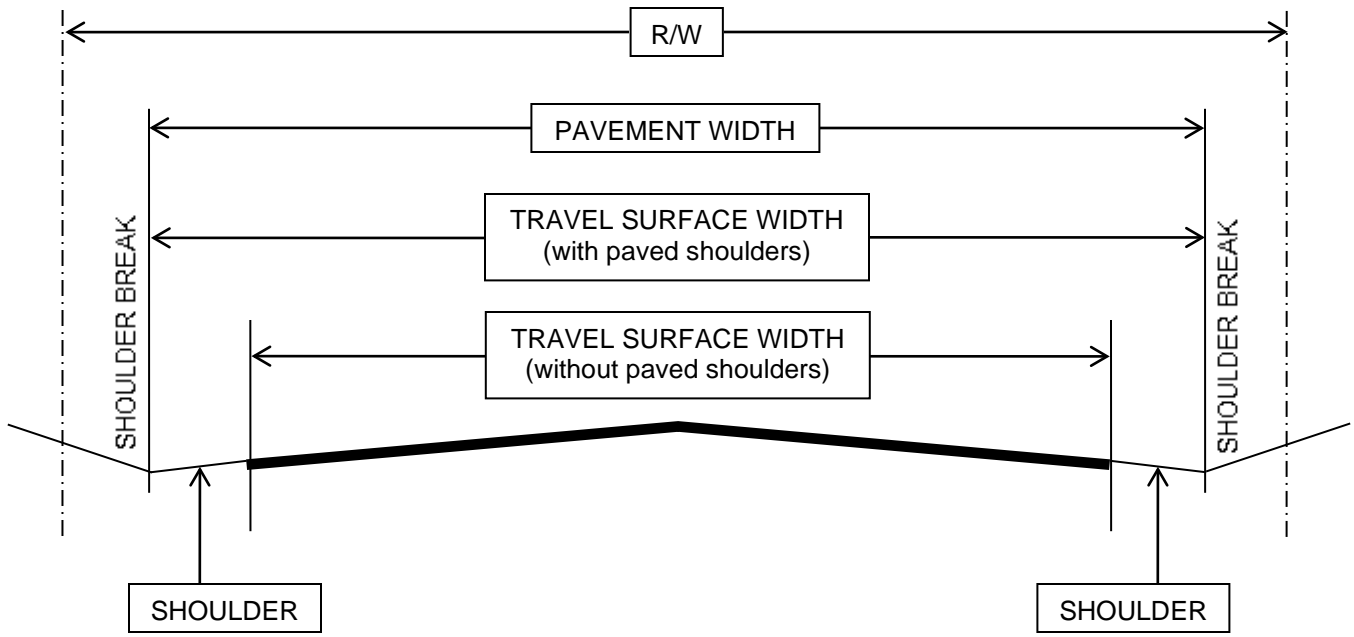

RURAL TYPICAL SECTION, (SHOULDER & DITCH LINE)

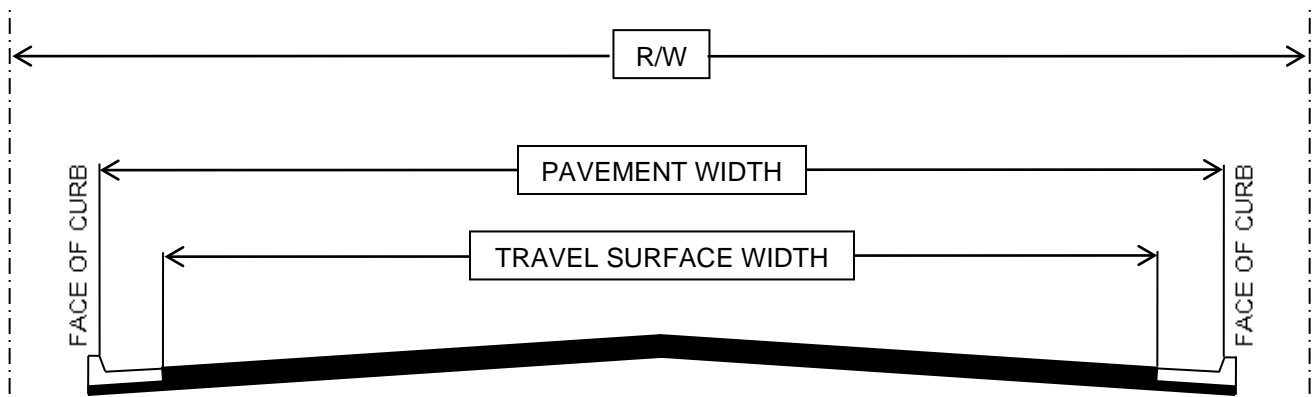

URBAN TYPICAL SECTION

Travel Surface and Pavement Width Diagram

Clarification of VDOT eligibility for street acceptance:

For VDOT acceptance, a street must meet one of the following criteria:

- Serves three or more occupied units
- Serves as a connector link between other streets
- Provides an extension of a street to the subdivision boundary for future continuity
- Serves as access to schools, churches, public recreational facilities, or similar public facilities
- Serves at least 100 vehicles per day generated by a business in advance of the occupancy of three or more.
- Part of the network of streets on the Comprehensive Plan

The VDOT Subdivision Street Requirements also states that a street that serves a retail shopping center may be considered to provide public service and be eligible of acceptance.

If there is any doubt about a street's eligibility, VDOT's Land Use Permit Manager can request a review by their Central Office.



COMMONWEALTH of VIRGINIA
DEPARTMENT OF TRANSPORTATION

PHILIP A. SHUCET
COMMISSIONER

14686 Avion Parkway
Chantilly, VA 20151
(703) 383-VDOT (8368)

THOMAS F. FARLEY
DISTRICT ADMINISTRATOR

July 31, 2002

MEMORANDUM

**To: NOVA District Residencies
NOVA District Permit Section**

**Re: Bridge Safety and Acceptance Inspections for Bridge Structures
Constructed by Developers or Local Municipal and Government Agencies**

As you are all aware, NOVA District Structure and Bridge is regularly requested to accept Bridges and culverts, constructed and inspected by developers or local municipal and government agencies, into the state maintenance system. Acceptance of a bridge, culvert, or related structure will require two (2) different inspections by the NOVA District Structure and Bridge Section.

- A **Bridge Safety/Inventory Inspection** is required **prior** to opening the structure to Public traffic
- A **Final Construction Inspection** is required **prior** to accepting the structure for VDOT maintenance. While it is suggested that these two (2) inspections be held simultaneously, that is not a requirement since on some projects this may not be practical.

A brief description of each inspection, and the documentation required from the developer or agency, is provided in the following paragraphs. To ensure consistent standards are maintained throughout the NOVA District, these requirements must be satisfied before structures are inspected and accepted by NOVA District Structure and Bridge.

Bridge Safety/Inventory Inspection

This inspection serves as the initial inspection of the structure. It is required by federal law to insure that the structure meets current design and safety criteria. Data gathered includes location, date completed/open to traffic, alignment, description, horizontal/vertical clearances, stream data, bridge element description and condition data, and traffic safety features. The information is entered into Virginia's Bridge Management System and a unique number is assigned to the structure for future in-service inspections or other actions.

For the inspection, the developers or government agency shall ensure that all *structural elements are accessible*. This requirement may dictate that the developer or agency provide:

- Man-lifts, bucket trucks, under bridge inspection vehicles, boats, or other equipment necessary to inspect the bridge.
- Plans, personnel, and equipment to implement traffic control measures.

The inspection shall be requested through the Permits Section or the appropriate VDOT Residency. The following information must be submitted along with the request.

- A copy of the approved design plans and shop drawings (“AS BUILT” changes should be included for work completed to date)
- Certified test reports of materials used to date.
- Certified test reports of foundations in place to date.
- Drainage information, i.e. drainage area, HEC II, etc.

In most cases, the structure must be substantially complete (i.e., roadway, curbs, and slopes on the approaches and underneath the structures are already in place) before the inspection will be performed.

Final Construction/Acceptance Inspection

Final Acceptance inspections will be conducted, in accordance with Section 105.15b of the VDOT Road and Bridge Specifications, to insure that the completed structure was constructed in accordance with the approved plans, standards, and specifications. The project field inspection staff, contractor, and representatives of the developer or government agency shall be in attendance during the inspection. As described for **Safety Inspections**, the developer or agency is responsible for providing traffic control measures and access to all bridge elements necessary for performing the inspection.

This inspection shall be requested through the Permits Section or the appropriate VDOT Residency. The following information must be submitted along with the request:

- A full size copy of “AS BUILT” plans and shop drawings, stamped by a Professional Engineer, and suitable for microfilming.
- Original approved working drawings, stamped by a Professional Engineer, of the support excavation design, mechanically stabilized wall systems, overhead sign support structures, welding details, product descriptions, catalog cuts, and other structural details required for the completion of the work.
- A compilation of certifications attesting to satisfactory results of tests of materials, workmanship, and adherence to the following quality control standards:
 - VDOT, Road and Bridge Standards, current version and Supplemental Instructional and Informational Memoranda.
 - VDOT, Road and Bridge Specifications, current version including Special Provisions.
 - VDOT, Manual of Instructions and Virginia Test Method Manual.

- A letter, signed and stamped by a Professional Engineer on behalf of the developer or agency, certifying that: “The bridges, culverts, retaining walls, signs, and other structures defined herein were, to the best of my knowledge, information, and belief, constructed in accordance with the approved plans and specifications for this project.”

Upon completion of this inspection a letter will be prepared, from the District Structure and Bridge Engineer to the Permit Section or Residency, recommending acceptance or specifying any deficiencies, including incomplete work, that must be resolved before the structure is accepted by VDOT. If a structure was not accepted, the developer or agency shall fix the deficiencies and notify the District Structure and Bridge Engineer by submitting a letter, signed and stamped by a Professional Engineer, certifying that the deficiencies have been corrected. Depending on the severity of the deficiencies, as judged by the District Structure and Bridge Engineer, another inspection may be performed or acceptance may be immediately recommended. If a bridge structure that is open to traffic is not accepted into the VDOT System prior to the next required Safety Inspection (normally two (2) years), the developer or local municipal and government agency is responsible for performing a Safety Inspection that confirms to the Code of Federal Regulations 23, Highways Part 650. Subpart C – National Bridge Inspection Standards.

This Memorandum clarifies, but does not change, the procedures and requirements specified in a previous memorandum dated April 28, 1999. Please provide a copy of this updated Memorandum to developers, contractors, and local municipal and government agencies in Your area of geographic responsibility. It is suggested it also be attached to the approved permit for the construction of any applicable structures.

Should you have any questions, please feel free to contact the District Structure and Bridge Engineer at (703) 383-2117.

Sincerely,

//Original signed//
Nicholas J. Roper, P.E.
District Structure and Bridge Engineer

cc: John Depasquale
Morteza Salehi

Subject: Request for inspection - Load ratings
Importance: High

All,

Please pass this on.

In the future when a developer / designer makes a request for the safety/inventory inspection for (**Bridges including con-spans**) a load rating needs to be included with the request.

Once the structure is open, then DMV may need to issue a permit to carry a large load across the structure. The load rating is very important; in case we get a call and asked for the load limitations on a structure. Waiting to request the load rating when a Final is completed takes too long.

Thank you for you attention to this matter.

Ray Judge

Nova Structure/Bridge

Safety Inspection Team Leader



COMMONWEALTH of VIRGINIA

DEPARTMENT OF TRANSPORTATION

3975 FAIR RIDGE DRIVE
FAIRFAX, VA 22033
(703) 383-VDOT (8368)

DAVID R. GEHR
COMMISSIONER

THOMAS F. FARLEY
DISTRICT ADMINISTRATOR

April 28, 1999

MEMORANDUM

To: NOVA District Preliminary Engineering Asst. Resident Engineers
NOVA District Permit Managers

Re: Bridge Safety and Acceptance Inspections for Bridge Structures
Constructed by a Locality or Developer

As you are all aware, NOVA District Structure and Bridge is regularly requested to accept bridges and culverts constructed and inspected by localities and/or developers. In an effort to be consistent throughout NOVA District, the following requirements must be met before the inspection and acceptance of structures by this office. It will require that the locality/developer have experienced staff and/or consultants to inspect and insure compliance with the approved design plans and specifications.

Acceptance of a bridge, culvert, or related structure will require two (2) different inspections by the NOVA District Structure and Bridge Section. A Bridge Safety/Inventory Inspection is required prior to opening the structure to public traffic. A Final Construction Inspection is required prior to accepting the structure for VDOT maintenance. While it is suggested that these two (2) inspections be held simultaneously, that is not a requirement since on some projects this may not be practical. Provided below is a brief description and the major requirements of each inspection.

Bridge Safety/Inventory Inspection

This inspection serves as the initial inspection of the structure. It is required by Federal Law and insures the structure meets current design and safety criteria. Data gathered includes location, date completed/open to traffic, alignment, description, horizontal/vertical clearances, stream data, and traffic safety features. This information is entered into Virginia's Bridge Management System and a unique number is assigned to the structure in order to insure the future in-service inspections. Access must be allowed to all structural elements, and load-supporting elements must be visible. In most cases, structures should have the roadway, curbs, and slopes in place before requesting this inspection.

This inspection should be requested through the County Permits Section and must include:

1. A copy of the VDOT and/or Locality approved design plans and shop drawings ("AS BUILT" changes should be included for work completed to date).
2. Certified test reports of materials used to date.
3. Certified test reports of foundations in place date.
4. Drainage information, i.e. drainage area, HEC II, etc.

Final Construction/Acceptance Inspection

This inspection will be conducted, with the project field inspection staff and the contractor and/or developer in attendance, to insure that the completed structure was constructed in accordance with the approved plans, standards, and specifications. Upon completion of this inspection a letter will be generated, on behalf of the District Structure and Bridge Engineer, outlining deficiencies or work that was incomplete. The structure will not be accepted by VDOT until all deficiencies have been resolved to the satisfaction of the District Structure and Bridge Engineer.

This inspection should be requested through the County Permits Section and must include:

1. A full size copy of "AS BUILT" plans and shop drawings, stamped by a Professional Engineer, and suitable for microfilming.
2. Original approved working drawings, stamped by a Professional Engineer, of the support excavation design, mechanically stabilized wall systems, overhead sign support structures, welding details, product descriptions, catalog cuts, and other structural details required for the completion of the work.
3. A compilation of certifications attesting to satisfactory results of tests of materials, workmanship, and adherence to the following quality control standards:
 - VDOT, Road and Bridge Standards. Current version and Supplemental Instructional and Informational Memoranda.
 - VDOT, Road and Bridge Specifications. Current version including current Special Provision Copied Notes and Special Provisions.
 - VDOT, Manual of Instructions and Virginia Test Method Manual.
4. A cover letter from the locality or signed and stamped by a Professional Engineer on behalf of the developer, certifying "The bridges, culverts, retaining walls, signs, and other structures defined herein were, to the best of my knowledge, information, and belief, constructed in accordance with the approved plans and specifications for this project."

Bridge Safety and Acceptance Inspections for Bridge Structures
Constructed by a Locality or Developer
April 28, 1999
Page 3 of 3

Should a section of roadway and bridge structure that is open to traffic not be accepted into the VDOT system prior to the next required Safety Inspection (normally two (2) years), a Safety Inspection conforming to the Code of Federal Regulations, 23 Highways Part 650, Subpart C – National Bridge Inspection Standards will be the responsibility of the locality or developer.

Please provide a copy of this letter to the localities and developers/contractors in your area of geographic responsibility. It is suggested that a copy of this letter also be attached to the approved permit for the construction of any applicable structures.

Should you have questions, please feel free to contact the District Structure and Bridge Engineer at 383-2117.

Sincerely,

//Original signed//
Ronaldo T. Nicholson, P.E.
District Structure and Bridge Engineer

cc: JoAnne Sorenson
Morteza Salehi
John Depasquale
Frank Edwards

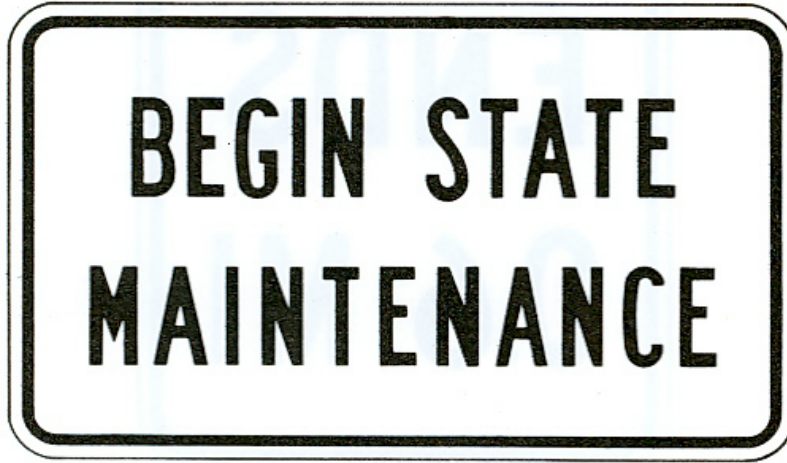

VG-8

This sign shall be erected at the beginning and end of those sections of routes maintained by the State. Line 1 shall be changed to read END STATE when erected at the end of State maintained roads.

SHAPE	Horizontal Rectangle	
COLOR	Message and Border: Field:	Black (non-reflective) White (reflectorized)
SIZE	Horizontal: Vertical:	36" 18"
MESSAGE	Line 1 Capitals: Line 2 Capitals:	4"D 4"D
MARGIN WIDTH	3/8"	
BORDER WIDTH	5/8"	
CORNER RADIUS	1 1/2"	
PUNCHING STANDARD	VII	

Intentionally blank



APPLICATION is hereby made for an in-place permit for utilities installed on subdivision streets to be accepted into the secondary system of state highways and as described below. Said activity(ies) has been done under and in accordance with the rules and regulations of the Commonwealth Transportation Board of Virginia, in so far as said rules are applicable thereto and any agreement between the parties herein before referred to. Applicant agrees to maintain work in an approved manner. Applicants to whom permits are issued shall at all times indemnify and save harmless the Commonwealth Transportation Board members of the Board, the Commonwealth and all Commonwealth employees, agents, and offices, from responsibility, damage, or liability arising from the exercise of the privileges granted in such permit to the extent allowed by law. In consideration of the issuance of a permit, the applicant agrees to waive for itself, successors in interest or assigns any entitlements it may otherwise have or have hereafter under the Uniform Relocation and Assistance Act of 1972 as amended in event the Department or its successor, chooses to exercise its acknowledged right to demand or cause the removal of any or all fixtures, personality of whatever kind or description that may hereafter be located, should this application be approved.

APPLICANT SHALL RECEIVE A PERMIT AT NO COST

Utility Company Name: _____ Tax ID number: _____

Address: _____

City: _____ State: _____ Zip Code: _____

Contact Name: _____ E-mail Address: _____

Phone Number:(_____) _____ - _____ Fax Number:(_____) _____ - _____

Subdivision Name: _____ Plan Approval Date: _____		
Geographically located in County / Town / City of: _____ Connecting to Highway Route Number: _____		
Type of utility (electrical, cable TV, telephone, water, sewer): _____		
Utility lines have been installed as shown on above-noted subdivision's plan within the right of way of the following streets:		
	STREET NAME	FROM TO
1		
2		
3		
4		
5		
6		
7		
8		
9		
10		

Applicant's Signature: _____ Title: _____ Date: _____

**Procedures for Obtaining a Land Use Permit
for
Landscaping and/or Irrigation Within the
Dedicated Right-of-Way of VDOT Maintained Roads**

1. The developer/consulting engineer/HOA will submit six (6) sets of landscaping plans to the PWC Department of Transportation Site Inspector Area Supervisor.
2. The Site Inspector Area Supervisor will forward these plans, along with a cover sheet, to the Manassas Residency Permit Manager for review and approval by the Virginia Department of Transportation (VDOT).
3. The Residency Permit Manager will then forward these plans to the NOVA District Land Development Section for coordination with the District Landscape Architect.
4. Once the landscaping plans are approved by the District Landscape Architect, the Land Development Section will return four (4) sets of the approved landscaping plans to the Residency Permit Manager.
5. The Residency Permit Manager will return the four (4) sets of plans to the PWC Department of Transportation Site Inspector Area Supervisor. Two (2) sets will be returned to the developer/consulting engineer/HOA and the remaining two (2) sets will be used for submission of the Land Use Permit application.
6. The Site Inspector Area Supervisor will notify the developer/consulting engineer/HOA that he/she must take the following steps to assist the county in obtaining the Land Use Permit from the Manassas Residency Office:
 - Submit proof of a minimum \$1 million liability insurance policy.
 - Coordinate with the Site Inspector to determine the cash escrow amount for the possible removal of landscaping. The Site Inspector will notify the Bond Administrator in writing (or email) of the required cash escrow amount.
 - Post the cash escrow with Bonds Administrator of the Planning Office.
 - Execute Prince William County's Standard Landscaping Agreement assuming the landscaping maintenance responsibility.

7. Upon receipt of the documents identified in Step 6 (above), the Site Inspector Area Supervisor will complete VDOT's Land Use Permit application. A copy of the Land Use Permit application will become a part of the VDOT street acceptance package.
8. At the time of VDOT street acceptance, the Land Use Permit application and two sets of landscape plans will be submitted to the Residency Permits Manager, who, on approval of the application request, will issue an approved Land Use Permit issued to Prince William County and return the approved permit along with one (1) set of plans to the Site Inspector Area Supervisor for placement in the project file.

Note:

If an irrigation system is to be installed within the dedicated right-of-way, it should be shown on the same set of plans for landscaping within the right-of-way. These plans must be approved by the Northern Virginia District Office prior to the installation of the irrigation system. If a decision to install the irrigation system is made after the landscaping plans are approved by VDOT, then it will be necessary to revise the landscaping plans to incorporate irrigation system for review and approval by the Northern Virginia District Office. Contact the Manassas Residency Permit Manager for additional information to obtain the Land Use Permit for the installation of irrigation system.

Flowchart for Landscaping in ROW

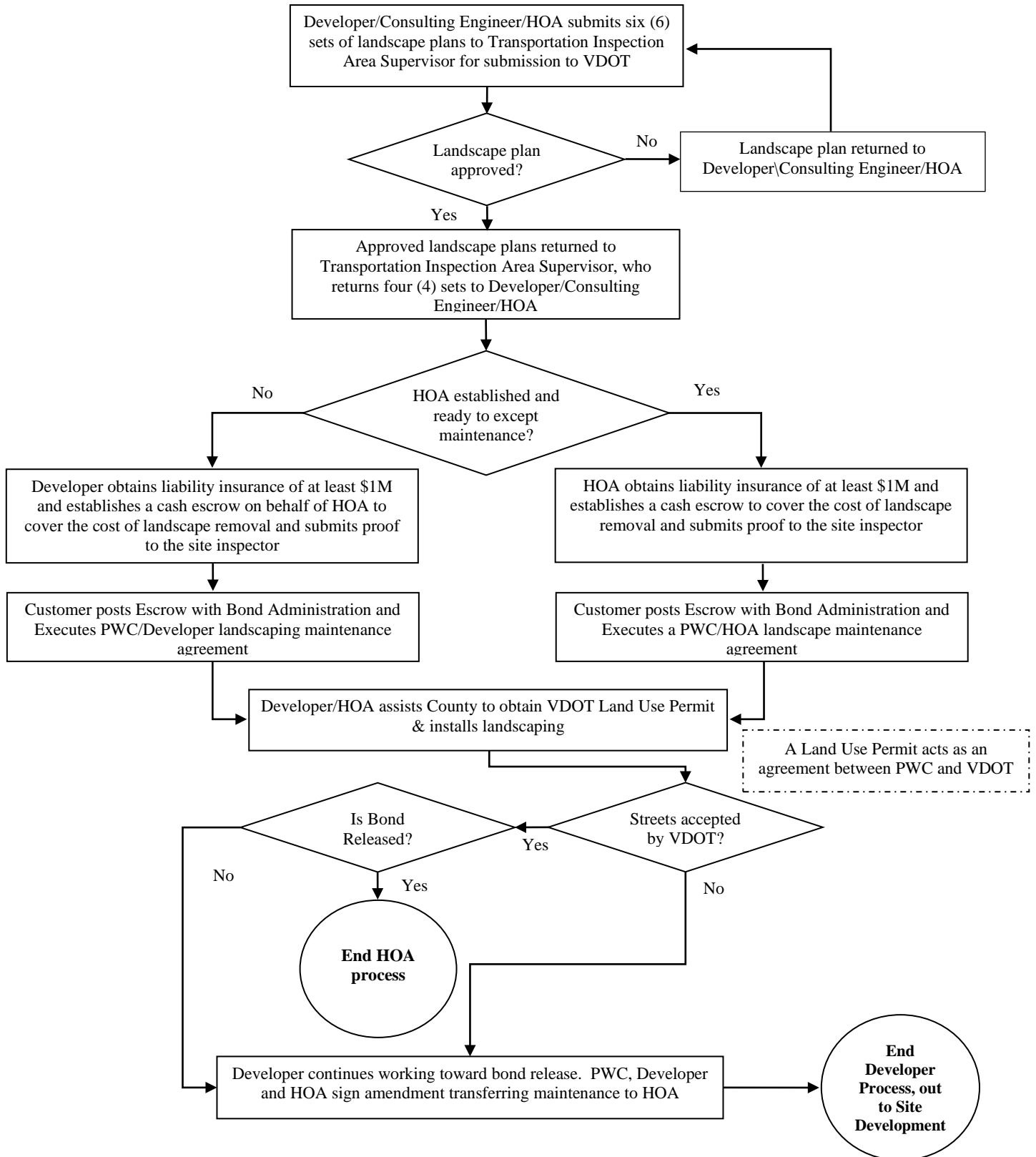



COUNTY OF PRINCE WILLIAM

5 County Complex Ct. Suite 290, Prince William, VA 22192-5308
(703) 792-6820 Metro 631-1703 Fax 792-6828

Department of
Transportation

LANDSCAPE MAINTENANCE AGREEMENT

**HOA ESTABLISHED AND READY TO ASSUME
LANDSCAPING MAINTENANCE RESPONSIBILITY**

This Agreement between the Board of County Supervisors of Prince William County, Virginia (the "Board"), a body corporate and politic, party of the first part, and

_____ (the "Association"),
and _____

_____ (the "Developer") parties of the second part, is entered into this _____ day of _____, _____, for the purpose of relieving the Board of maintenance responsibility for certain landscaping which is assumed under a Land Use Permit issued by the Virginia Department of Transportation "VDOT" for the project known as _____, plan number _____.

The parties of the second part shall assist Prince William County in applying for and obtaining a Land Use Permit issued by the Virginia Department of Transportation for certain landscaping within the right-of-way. The parties of the second part shall bear all costs associated with the preparation and processing of the Land Use Permit Application and attachment hereto, including review and permit fees, bonds, and costs to produce engineering drawings and plans.

The Association agrees to assume all of the maintenance responsibility set forth in the Land Use Permit issued for the location of this landscaping, which maintenance responsibility had previously been assumed by the Board in order to obtain the Land Use Permit.

The Association agrees that in the execution of this responsibility, they will perform the beautification work and the other requirements of Land Use Permit, to the standards required by VDOT, and will also maintain insurance of at least \$1,000,000 to cover any liability which might occur. The Association will also be responsible for all future maintenance of the landscaping approved under the Land Use Permit, to the standards required by VDOT.

To secure their obligation and protect the Board from any violation of the Land Use Permit, the parties of the second part agree to post the amount of \$_____, in cash with the Board, which represents the estimated cost of removal of the landscaping. This cash will be held in escrow, administered by Prince William County as other construction accounts are administered. In the event that VDOT notifies the Board that the Land Use Permit has been violated, or the Land Use Permit has been revoked, then the Board is authorized to remove the landscaping, and to withdraw the funds deposited pursuant to this agreement for this purpose.

In witness hereof, the parties have caused this Agreement to be executed by their duly authorized officers.

BOARD OF COUNTY SUPERVISORS OF PRINCE WILLIAM COUNTY, VA

By: _____
Director of Transportation (Print)

Director of Transportation (Sign)

By: _____
Developer/Dev's Rep (Print)

By: _____
Developer/Dev's Rep (Sign)

By: _____
Title

Phone: _____

Address: _____

By: _____
H.O.A. Representative (Print)

By: _____
H.O.A. Representative (Sign)

By: _____
Title

Phone: _____

Address: _____



COUNTY OF PRINCE WILLIAM
5 County Complex Ct. Suite 290, Prince William, VA 22192-5308
(703) 792-6820 Metro 631-1703 Fax 792-6828

Department of
Transportation

LANDSCAPE MAINTENANCE AGREEMENT

HOA NOT ESTABLISHED/ HOA DOES NOT ASSUME LANDSCAPING MAINTENANCE RESPONSIBILITY

This Agreement between the Board of County Supervisors of Prince William County, Virginia (the "Board"), a body corporate and politic, party of the first part, and _____, a Virginia Corporation (or a _____ corporation, licensed to do business in the Commonwealth of Virginia) (the "Developer") party of the second part, is entered into this _____ day of _____, _____, for the purpose of relieving the Board of maintenance responsibility for certain landscaping which is assumed under a Land Use Permit issued by the Virginia Department of Transportation "VDOT" for the project known as _____, plan number _____.

The Developer shall assist Prince William County in applying for and obtaining a Land Use Permit issued by the Virginia Department of Transportation for certain landscaping within the right-of-way.

The Developer shall bear all costs associated with the preparation and processing of the Land Use Permit Application and attachment hereto, including review and permit fees, bonds, and costs to produce engineering drawings and plans.

The Developer agrees to assume all of the maintenance responsibility set forth in the Land Use Permit issued for the location of this landscaping, which maintenance responsibility had previously been assumed by the Board in order to obtain the Land Use Permit.

The Developer agrees that in the execution of this responsibility, they will perform the beautification work and the other requirements of Land Use Permit, to the standards required by VDOT, and will also maintain insurance of at least \$1,000,000 to cover any liability which might occur. The Developer will also be responsible for all future maintenance of the landscaping approved under the Land Use Permit, to the standards required by VDOT.

The Developer shall maintain the landscaping until such time as the maintenance responsibility is transferred by the Developer to the Homeowners' Association by a written amendment to this agreement signed by all parties.

To secure Developer's obligation and protect the Board for any violation of the Land Use Permit, the Developer agrees to post the amount of \$_____, in cash with the Board, which represents the estimated cost of removal of the landscaping. This cash will be held in escrow account, administered by Prince William County, as other construction accounts are administered. In the event that VDOT notified the Board that the Land Use Permit has been violated, or the Land Use Permit has been revoked, then the Board is authorized to remove the landscaping, and to withdraw the funds deposited pursuant to this agreement for this purpose.

In witness hereof, the parties have caused this Agreement to be executed by their duly authorized officers.

BOARD OF COUNTY SUPERVISORS OF PRINCE WILLIAM COUNTY, VA

By: _____
Director of Transportation (Print)

Director of Transportation (Sign)

By: _____
Developer/Dev's Rep (Print)

By: _____
Developer/Dev's Rep (Sign)

By: _____
Title

Phone: _____

Address: _____

**ESCROW COMPUTATIONS FOR LANDSCAPING ITEMS
WITHIN THE VDOT RIGHT-OF-WAY**

Development _____

Please use the following guidelines based on the current Unit Price List to determine the escrow amount for the removal of landscape items from the right-of-way.

Example:

\$165.00 each for the first twenty (20) trees up to 2" tree calipers

\$115.00 for each tree over the first twenty (20) trees up to 2" caliper

\$500.00 for each large existing tree

Escrow Amount:

First 20 trees \$165.00 x ____ = \$ _____

Remaining trees \$115.00 x ____ = \$ _____

Large existing trees \$500.00 x ____ = \$ _____

Total Escrow \$ _____

***There is no escrow required for shrubs**



APPLICATION is hereby made for permit as shown on the accompanying plan or sketch and as described below. Said activity(s) will be done under and in accordance with the rules and regulations of the Commonwealth Transportation Board of Virginia, in so far as said rules are applicable thereto and any agreement between the parties herein before referred to. Where applicable agreements may be attached and made a part of the permit assembly including any cost responsibilities covering work under permit. Applicant agrees to maintain work in a manner as approved upon its completion. Applicant also hereby agrees and is bound and held responsible to the owner for any and all damages to any other installations already in place as a result of work covered by resulting permit. Applicants to whom permits are issued shall at all times indemnify and save harmless the Commonwealth Transportation Board members of the Board, the Commonwealth and all Commonwealth employees, agents, and offices, from responsibility, damage, or liability arising from the exercise of the privileges granted in such permit to the extent allowed by law. In consideration of the issuance of a permit the applicant agrees to waive for itself, successors in interest or assigns any entitlements it may otherwise have or have hereafter under the Uniform Relocation and Assistant Act of 1972 as amended in event the Department or its successor, chooses to exercise its acknowledged right to demand or cause the removal of any or all fixtures, personality of whatever kind or description that may hereafter be located, should this application be approved.

TYPE OR PRINT CLEARLY

Driver's license or Tax ID number _____ Owner Name _____ Address _____ City _____ State _____ Zip Code _____	Contact Name _____ E-mail Address _____ Phone Number (_____) _____ - _____ Emergency Number (_____) _____ - _____ Fax Number (_____) _____ - _____
Driver's license or Tax ID number _____ Agent Name _____ Address _____ City _____ State _____ Zip Code _____	Contact Name _____ E-mail Address _____ Phone Number (_____) _____ - _____ Emergency Number (_____) _____ - _____ Fax Number (_____) _____ - _____
Permit Term Requested _____ Fees Enclosed \$ _____ Check Number _____ Coupon Number(s) _____ Money Order _____ Other _____ Estimated cost of work to be performed on VDOT Right of Way \$ _____	
Surety Information: Surety Company Name _____ Amount of Surety \$ _____ Obligation Amount \$ _____ Check # _____ Bond # _____ ILC # _____ <input type="checkbox"/> Corporate Surety <input type="checkbox"/> Resolution <input type="checkbox"/> Ordinance <input type="checkbox"/> Waived	
The Surety posted by Owner () or Agent () Surety Refunds paid to Owner () or Agent()	
<p style="text-align: center;"><u>Applicant has provided proof of the following requirements in accordance as defined in Code of Virginia section 2.2-1151.1.</u></p> <p>(1) The utility company has registered as an operator with the appropriate notification center. (2) Attached is a notarized affidavit, that the utility owner has notified the commercial and residential developer, owner of commercial or multifamily real estate, or local government entities with a property interest in any parcel of land located adjacent to the property over which the land use is being requested, that application for the permit has been made.</p>	

Request Permission: To perform the following activity(s)

 _____ as per attached plans.

Location: Tax Map Number _____ Applicant Job No. _____
 Geographically in County / Town / City of _____ On Highway Route and /or Name _____
Between Route _____ St. Name _____ Latitude _____ Longitude _____
And Route _____ St. Name _____ Latitude _____ Longitude _____

IF APPLICABLE, I AGREE TO PAY THE FULL SALARY AND EXPENSES OF A STATE ASSIGNED INSPECTOR IN CONJUNCTION WITH THIS PROJECT, COVERED BY ACCOUNT RECEIVABLE NUMBER.

Signature of applicant _____ **Title** _____ **Date** _____
Signature of agent _____ **Title** _____ **Date** _____

All applicable items on this form must be completed before your request can be considered. Recheck information furnished to avoid delay. Prepayment Required - make Remittance payable to Virginia Department of Transportation.

VDOT USE ONLY

Receipt is hereby acknowledged of CHECK _____ COUPON _____ M.O. _____ In The Amount of \$ _____ Permit Fee \$ _____ Cash Surety \$ _____, VDOT Reference Number _____ Signed _____ VDOT.



Permittee Agreement for Land Use Permit Issuance

Section 24VAC 30-151-620 of the Virginia Department of Transportation (VDOT) Land Use Permit Regulations stipulates that permits may be issued of the placement and maintenance of plant materials by individuals or organizations on non-limited access state maintained highways.

I, the undersigned hereby acknowledge that I am fully cognizant of all of the following requirements associated with the issuance of a VDOT Land Use Permit authorizing the installation and maintenance of plant material on state maintained rights-of-way:

Applicant Name: _____

Applicant Signature: _____

Project Name: _____

Route Number: _____ **County:** _____

All proposed landscaping activities shall be clearly outlined and a sketch/plan of same shall be submitted to the district administrator's designee with the permit application and all other information necessary to process the permit request.

The permittee and/or their agent shall be responsible for completion of all landscaping installed under the auspices of a land use permit.

The permittee and/or their agent shall be responsible for the perpetual maintenance of all landscaping installed within state maintained rights-of-way under the auspices of a land use permit.

The permittee and/or their agent shall notify the local VDOT permit office prior to initiating the installation and/or maintenance of landscaping within state maintained rights-of-way.

The permittee and/or their agent may replace any dead, dying or diseased plant material with the same variety, in the same location under the terms and conditions of the land use permit issued for the initial installation.

The installation and/or maintenance of landscaping within state maintained right-of-way must not obstruct or interfere with existing drainage conveyance.

The permittee and/or their agent shall be responsible for removal, disposal and clean-up of all debris generated by the installation and/or maintenance of authorized landscaping located within state maintained rights-of-way. The permittee and/or their agent must apply for a new land use permit for the installation of new plant material not authorized under the auspices of the original land use permit.

The permittee and/or their agent must obtain VDOT approval prior to the storage of materials within state maintained rights-of-way.

VDOT shall have the authority to remove any landscaping placed within state maintained rights-of-way if it is determined that the landscaping is deemed a traffic hazard, or is found in conflict with future utility operations, roadway improvement projects and/or roadway maintenance activities.

The permit may be terminated in the following cases:

- A. By the permittee, upon ten (10) days written notice to VDOT.
- B. By VDOT, in accordance with section 24VAC30-151-50, failure to comply with provisions of the Land Use Permit Regulations (24VAC30-151) or the conditions of this permit. If at any time the permittee fails to comply with the terms and conditions of the Land Use Permit Regulations, VDOT reserves the right to reclaim and restore the landscaped area to its original condition or establish grass.
- C. By VDOT, upon written notice to the permittee.

All costs associated with the removal of landscape features and right-of-way restoration shall be borne by the permittee should they violate conditions of the permit or request termination of the permit.

The preceding provisions are intentionally condensed in format and should not be loosely interpreted by the permittee without consultation with the central office permit manager and affirmation from the Land Use Permit Regulations.



Section 24VAC30-151-580 of the Virginia Department of Transportation (VDOT) Land Use Permit Regulations stipulates that a VDOT Land Use Permit shall be obtained for the placement on all non-transportation related elements such as privately maintained irrigation systems on state maintained highways.

VDOT Land Use Permit Required by Law

The General Rules and Regulations of the Commonwealth Transportation Board are adopted pursuant to the authority of the Code of Virginia. These rules and regulations provide that no work of any nature shall be performed on any real property under the ownership, control, or jurisdiction of VDOT until written permission has been obtained from VDOT. Real property includes, but is not limited to, the right-of-way of any highway in the state highways system. Written permission is granted either by permit or a state-authorized contract let by VDOT;

By issuing a permit, VDOT is giving permission only for whatever rights it has in the right-of-way; the permittee is responsible for obtaining permission from others who may also have an interest in the property;

The permittee will be civilly liable to the Commonwealth for expenses and damages incurred by VDOT as a result of violation of any of the rules and regulations of this chapter. Violators shall be guilty of a misdemeanor and, upon conviction, shall be punished as provided for in § 33.1-19 of the Code of Virginia.

Application Requirements

Applications made for a land use permit authorizing the placement of privately maintained irrigation systems within state maintained right-of-way shall be made through the district administrator's designee. The district administrator's designee will coordinate review and approval of the request with the appropriate VDOT personnel prior to permit issuance;

Application forms and general information regarding VDOT land use permitting for irrigation systems can be obtained by contacting the district permit office or the central office permit manager. The forms necessary to make application are the LUP-A Land Use Permit Application, an executed LUP-SP Special Provisions form, an executed LUP-ESCCC Erosion & Sediment Control Contractor Certification form, an executed LUP-WZTCC Work Zone Traffic Control Certification form and a LUP-SB Permit Surety Bond or a LUP-LC Irrevocable Letter of Credit Bank Agreement.

This information may also be obtained on the VDOT web site at:

<http://www.virginiadot.org/business/bu-landUsePermits.asp> or at <http://vdotforms.vdot.virginia.gov>

A list of counties with their corresponding VDOT district offices and VDOT contact information may be obtained on the VDOT web site at: <http://www.virginia.org/about/districts.asp>.

Permit Fees & Charges

The land use permit application shall include a check or cash in the amount of \$100.00 for processing of the request.

Surety Requirement

A continuous surety in an amount to be determined by the district administrator's designee is required to cover possible damage to roads, sidewalks, curbs, existing utilities, traffic control devices, and other facilities within state maintained right-of-way caused by malfunction or failure of the irrigation system. This surety must remain in effect as long as the irrigation system remains within the right-of-way. The surety may be in the form of cash or check, a surety bond or an irrevocable letter of credit bank agreement.

Insurance Requirements

The permittee shall secure and maintain sufficient insurance to protect against liability for personal injury and property damage that may arise from the installation of a privately maintained irrigation system within state maintained right of way. Insurance must be obtained prior to commencement of the permitted activity and shall remain valid shall remain in full force as long as the irrigation system remains within the right-of-way. The district administrator's designee may require a valid certificate or letter of insurance from the issuing insurance agent or agency prior to issuing the land use permit.

General Requirements

The installation of privately maintained irrigation systems within limited access right-of way shall not be permitted;

The applicant shall provide VDOT with all drawings, technical specifications, and all other pertinent documentation relating to the proposed installation of a privately maintained irrigation system within state maintained right-of-way prior to initiating the installation of said system. The irrigation system shall be designed and/or approved by a qualified irrigation designer;

All main lines and laterals located within state maintained right-of-way shall be installed at a minimum depth 24 inches. The applicant is responsible for procuring information necessary regarding the exact location of all existing utilities or obstructions located at the site and showing on the irrigation plans;

All irrigation lines passing beneath a road or sidewalk shall be appropriately sleeved to protect the pipe and assist with system maintenance. The location of protection sleeves shall be included in the design of the system to be submitted for VDOT review and approval. The material utilized for trench backfill shall be specified and extend to the bottom of the adjacent roadway sub-base layer;

All sprinkler heads shall not elevate more than 12 inches above existing grade when in operation and must remain flush with the existing grade when dormant. The sprinkler spray shall be designed to provide for a fixed spray regulating pattern appropriate for the area to be irrigated. Each sprinkler head shall have a spring activated pressure regulator integral within the stem of the sprinkler head;

Consideration shall be given to the drainage patterns within the irrigated area. VDOT standard under drains and/or edge drains shall be utilized, especially within islands, medians and along the edge of pavement, to eliminate the possibility of saturation of the pavement sub-base and/or the sub-grade within the roadway prism;

Main lines, laterals or sprinkler heads shall not be located within 18 inches of the edge of pavement, back of curb, sidewalk or other hard structure. Where there is no barrier, the entire irrigation system shall be located out of the clear zone as determined by the design speed;

Sprinkler heads and water lines shall not conflict with the location of existing utilities, traffic information signs, and/or other fixed traffic control devices;

All irrigation systems installed within state maintained right-of-way shall be zoned separately from the system zoning on private property. Each zone shall be equipped with a pressure regulating valve that increases the water droplet size;

All irrigation lines located within state maintained right-of-way shall be charged only when irrigation is in progress and remain uncharged when irrigation is not underway;

All exposed control devices must be vandal resistant. VDOT personnel shall have continuous access to a manual shut off valve for the portion of the irrigation system located within state maintained right-of-way;

Any alterations to an irrigation system located within state maintained right-of-way under the auspices of a VDOT land use permit must be resubmitted to VDOT for approval;

Final approval of all irrigation systems located within state maintained right of way shall be contingent upon inspection of the system in full operation by a representative of VDOT;

The applicant shall provide VDOT with an executed "Perpetual Maintenance and Responsibility Agreement" to include the following provisions:

- VDOT shall not be responsible for maintaining, repairing, or be in any way liable for the irrigation system within state maintained right-of-way.
- All required replacement or relocation of the irrigation system due to conflict with a future roadway improvement project shall be the responsibility of the permittee. The modification to an existing irrigation system resulting from a future roadway improvement project must be submitted to the District Administrator's designee for approval. VDOT shall advise the permittee of proposed roadway improvement project affecting their irrigation system upon finalization of the roadway improvement design.
- The permittee shall not modify the irrigation system design after VDOT approval has been granted through the issuance of a land use permit. Any proposed system modifications shall be submitted to VDOT for re-approval. VDOT may request removal of any unapproved modifications.
- The permittee agrees to indemnify and save harmless VDOT, the Commonwealth Transportation Board, and all of its officers, agents, and employees from all suits, actions or claims of any character, name or description, and/or functioning of the work authorized under the auspices of a VDOT Land Use Permit.
- The permittee shall be responsible for the perpetual maintenance of the irrigation and landscaping (to include turf grass) within state maintained right-of-way through a maintenance agreement that will remain in effect as long as the irrigation system remains within the right-of-way.
- The permittee shall take sufficient care to avoid damage to roads, sidewalks, curbs, existing utilities, traffic control devices, and other facilities within state maintained right-of-way and shall be held liable for any damages caused by the irrigation system.
- The irrigation system shall be designed to avoid over-throw of water onto the paved roadway surface and side walk, if applicable.
- The permittee is in agreement that VDOT may request disconnection of the portion of the irrigation system located within state maintained right-of-way should, in the opinion of VDOT, the irrigation system become a traffic and/or pedestrian hazard.
- The watering schedule for irrigation systems located within state maintained right of way, excluding maintenance and system checks, shall be restricted to between 12:00AM and 4:00AM on weekdays during periods of low traffic. At no time shall the system be operated during the weekday hours of 6:00AM to 9:30AM or 3:00PM to 6:30PM. The watering schedule shall be provided in the permit application package. Written permission from VDOT will be required to alter the scheduled irrigation times noted herein. System operation shall not be allowed when the air temperature is 40 degrees F or less.
- A winterization schedule shall be included in the design of the irrigation system.
- The irrigation system shall fully comply with all local and state laws and ordinances, and with all established code application relating to the installation and maintenance of privately maintained irrigation systems.
- The irrigation system zone(s) located within state maintained right-of-way shall not be used for applying pesticides, fertilizers, or any other additives that may contaminate the groundwater.
- VDOT shall remove any irrigation system located within state maintained right-of-way at the permittees expense should the permittee fail to properly maintain the irrigation system.

Traffic Control

The permittee shall comply with all applicable provisions of the Virginia Work Area Protection Manual during installation and or maintenance of the irrigation system located within state maintained right-of-way;

If deemed necessary, trained flag persons are to be provided by the permittee during installation and maintenance of the irrigation system located within state maintained right of way;

All flag persons shall be trained in appropriate traffic control and successfully complete the VDOT flagging certification examination. VDOT flagging certification can be obtained through the VDOT Traffic Engineering Division, Work Zone Safety Section.

Permit Revocation

At the discretion of the district administrator's designee, the land use permit may be revoked and the irrigation system removed from with state maintained right of way should operation of the irrigation system become detrimental to state maintained facilities or the system is deemed hazardous for vehicular and or pedestrian traffic.

Permittee Notice

The preceding provisions are intentionally condensed in format and should not be loosely interpreted by the permittee without consultation with the central office permit manager or the district administrator's designee and affirmation from the Land Use Permit Regulations.

Virginia Department of Transportation Manassas Residency Street Acceptance Process

Legend

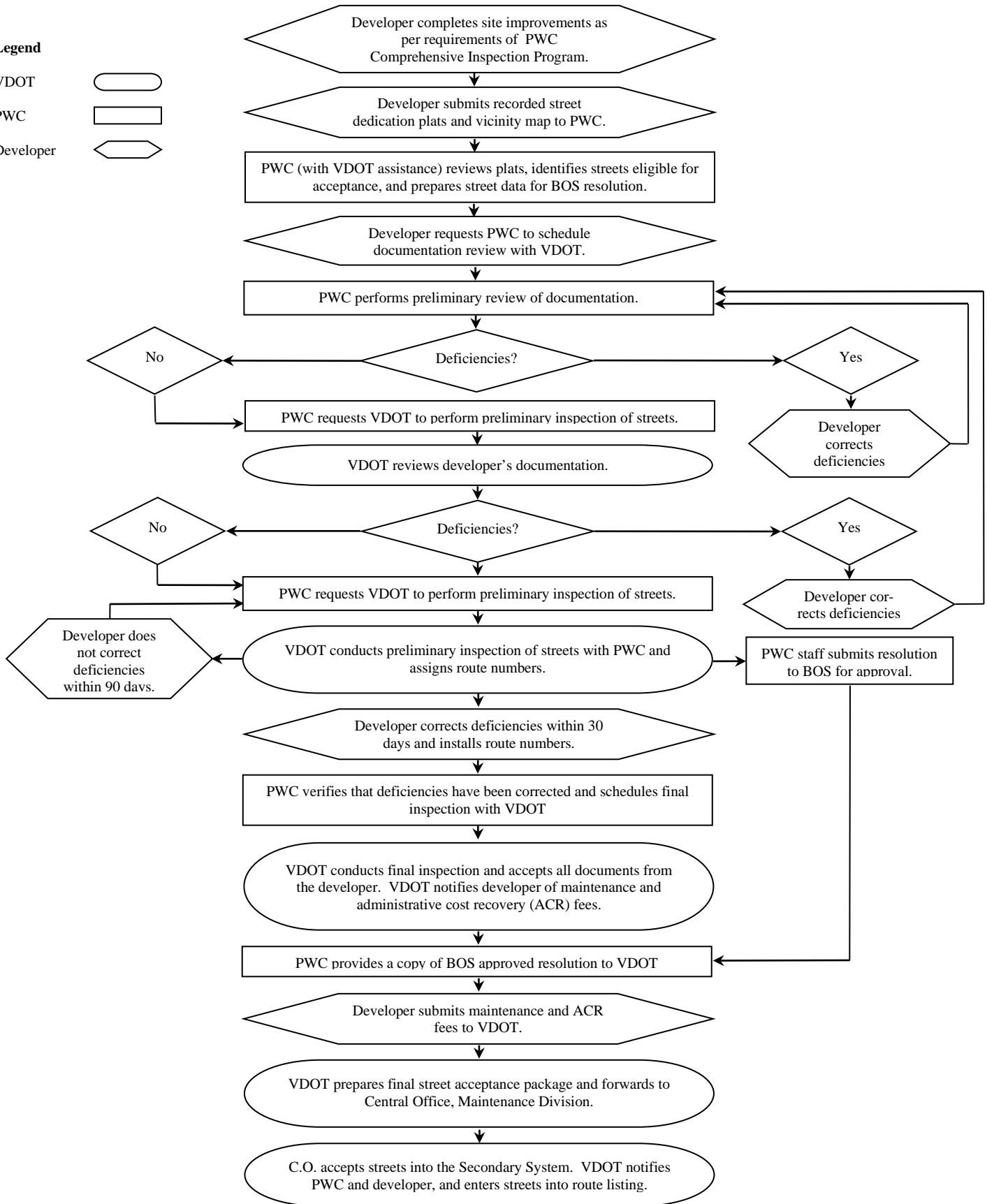
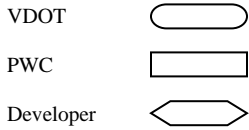

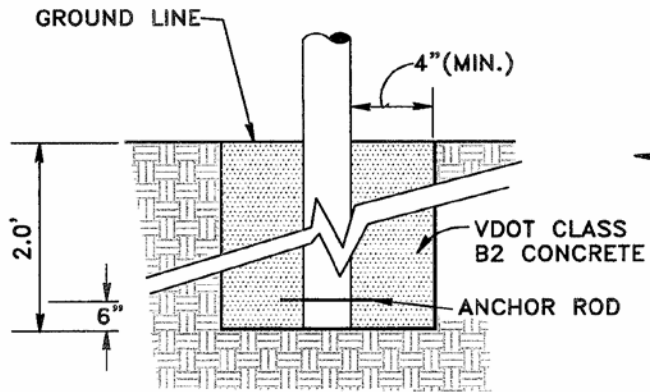
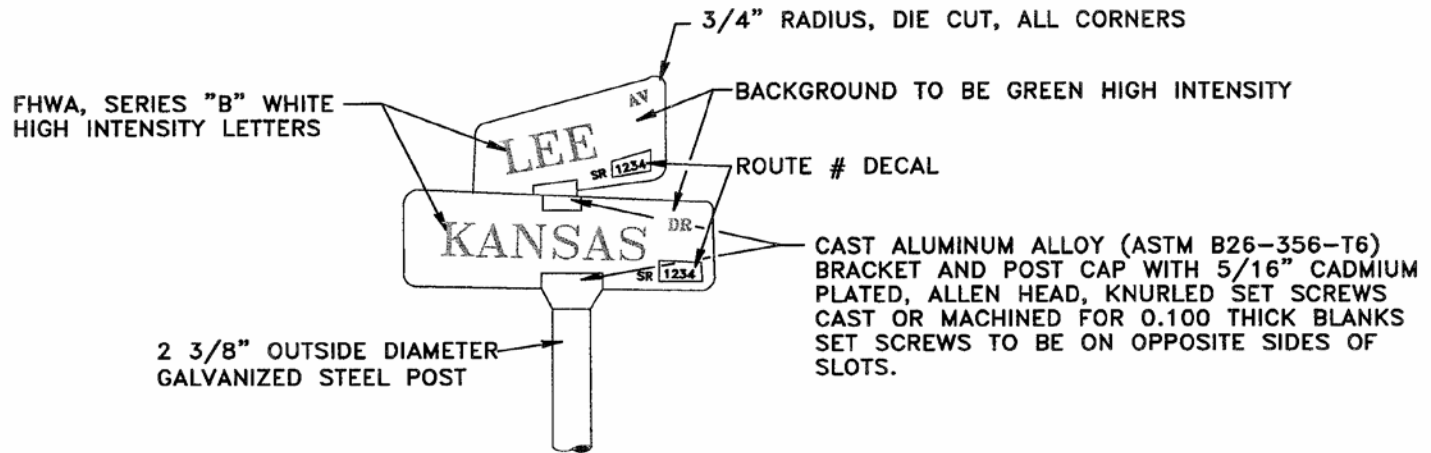

OR

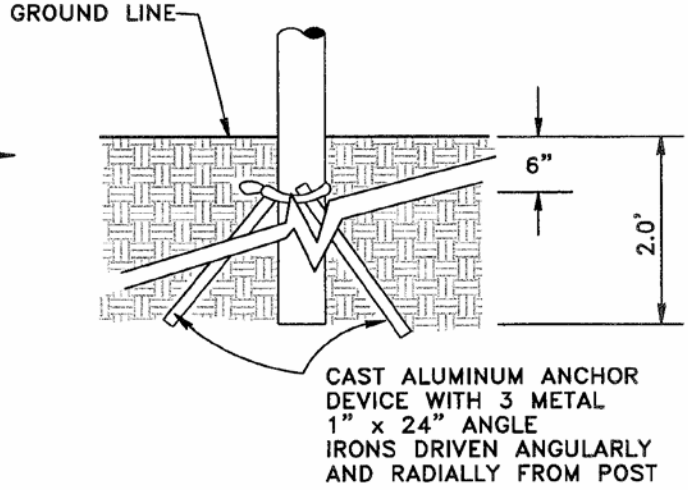

Detail No.	SNS-1		COUNTY OF PRINCE WILLIAM VIRGINIA	STREET NAME STANDARD	Rev. No.3
650.45					Date 10/02 1/29/96

GENERAL NOTES:

1. Street name signs shall conform to the standards in the table below for sizes as follows:

Size A: Subdivision streets

Size B: Arterials, parkways and collector streets

Shape Horizontal Rectangle

Color
 Message: White (Reflectorized)
 Field: Green (Reflectorized)

Size *		Size A	Size B
Street Name Sign	Horizontal	24 in.min.	30 in min.
	Horizontal	42 in. max.	48 in. max.
	Vertical	6 in. min.	9 in. min.
Route Decal	Horizontal (Field)	8 in.	12 in.
	Vertical	1.25 in.	2.50 in.
Message			
* Street Name Sign	Prefix Capitals	2 in. C	3 in. C
	Street Name Capitals	4 in. C	6 in. C
	Suffix Capitals	2 in. C	3 in. C
	Back Number Numerals	2 in. C	3 in. C
Route Decal	Capitals/Numerals	1 in. C	2 in. C

* Dimensions may be modified as approved by the Director of Transportation.

Detail No.	SNS-1		COUNTY OF PRINCE WILLIAM VIRGINIA	STREET NAME SIGN STANDARD	Rev. No.
650.45					Date 5/3/99

VIRGINIA DEPARTMENT OF TRANSPORTATION
SPECIAL PROVISION FOR
SQUARE TUBE STEEL SIGN POST

July 7, 2005

I. DESCRIPTION

This work shall consist of furnishing and installing square tube steel sign post for erecting signs in accordance with this specification and as shown on the plans or as directed by the Engineer

II. MATERIALS

- (a) Steel for sign post shall be hot-rolled, carbon sheet steel, structural steel quality, conforming to the requirements of ASTM A 1011, Grade 50 except the yield strength after cold-forming shall be 41368S-kPa [60,000-psi] minimum. Steel mounting brackets shall conform to the requirements of ASTM A36.
- (b) Galvanizing of sign post shall conform to the requirements of ASTM A653, coating Designation G-90. Galvanizing of the mounting brackets shall conform to the Requirements of ASTM A123.
- (c) Concrete shall be bagged mixtures such as Sacrete® or Quickrete®
- (d) Hardware (bolts, washers, etc.) for mounting sign post, anchors, slip bases, etc. shall be as recommended by the anchoring system manufacturer and shall be fabricated from corrosive resistant materials or be coated to resist corrosion.

III. PROCEDURES

The steel wall thickness shall be 1.897-mm [14-gauge] for the 50-mm [2-inch] by 50-mm [2-inch] posts. The steel wall thickness shall be 3.416-mm [10-gauge] for the 63-mm [2 ½-inch] by 63-mm [2 ½-inch] posts. Posts (inside and outside) shall be galvanized in accordance with the requirements of ASTM A653, Coating Designation G-90. Posts shall use a 900-mm [36-inch] minimum depth in-ground anchor system that provides a stable installation and allows easy replacement of the sign post into the anchor system after vehicle impact. A concrete collar having a diameter and depth of 300 mm [12-inch] shall be formed around the anchor for 50-mm[2-inch] post. Anchor systems for 63-mm [2 ½-inch] posts shall include slip bases and concrete foundations. Top of the collar or foundation shall be flush with the top of the earth and the anchor shall be centered in the collar or foundation. Sacrete, Quikrete, or other bagged mixtures of concrete as approved by the Engineer are acceptable for use for forming the collar or foundation.

Where posts are to be mounted on a retaining wall or barrier, the Contractor shall provide a mounting bracket, fabricated from steel conforming to the requirements of ASTM A36 and hot dipped galvanized in accordance with ASTM A123. Mounting bracket shall be designed so no connection to the barrier is made on the traffic side of the barrier and shall be secured to the barrier and wall using stainless steel chemically adhesive anchors.

Posts shall conform to breakaway requirements of AASHTO's Standard Specifications for Structural Supports for Highway Signs, Luminaires, and Traffic Signals (1994 Edition including revisions). The Contractor shall provide a copy of the FHWA's acceptance letter indicating compliance with breakaway requirements at the time of catalog submission of the posts. Posts shall have 11-mm (+/- 0.397-mm) [7/16-inch (+/- 1/64-inch)] openings or knockouts spaced 25-mm [1-inch] on centers on all four sides. Posts shall be installed in accordance with the manufacturer's recommendations. The Contractor shall

provide shop drawings of the posts, anchors, mounting brackets and stainless steel chemically adhesive anchors to the Engineer for approval prior to installation.

No more than two 50-mm [2-inch] posts or three 63-mm [2 ½-inch] posts shall be installed within a span of 2.1-meters [7-feet].

Posts, anchor system and slip bases shall be installed in accordance with the manufacturer's recommendations and the additional requirements herein. Installation shall result in the posts being plumb. Drive caps of the proper size shall be used during the installation of the anchor system to prevent damage.

Framing of the signs and attachment to the square steel tube sign post shall be in accordance with Standard WSP-1 except:

- Carriage bolts of the same diameter and material as the lag bolts shown in WSP-1 shall be used for attachment of the sign to the sign post. A hex nut and flat washer shall be used with the carriage bolt. Alternate attachment methods may be submitted for approval.
- Type A zee bars shall be used for sign installations on multiple posts or for installation of multiple signs. Alternate methods may be submitted for approval.

The Contractor shall establish the location of each sign post with a stake bearing the number or identification designated on the plans. The Engineer, accompanied by the Contractor, will inspect the locations and advise the Contractor of any necessary adjustments.

STP-1

FOUNDATION DETAILS

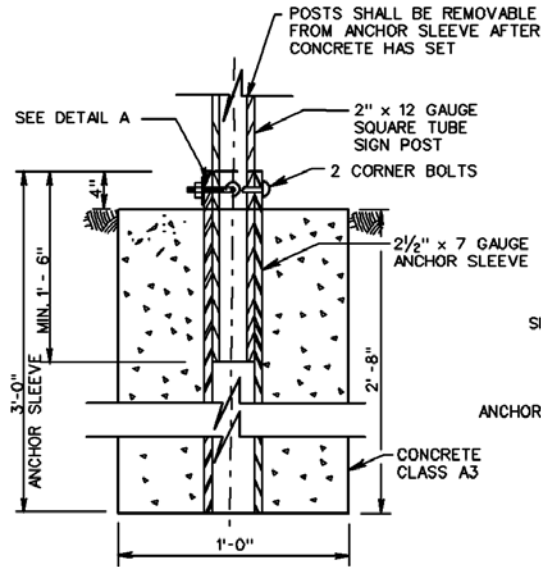

DETAIL A

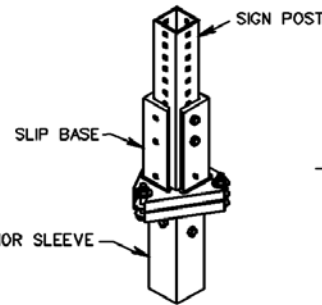

DETAIL B

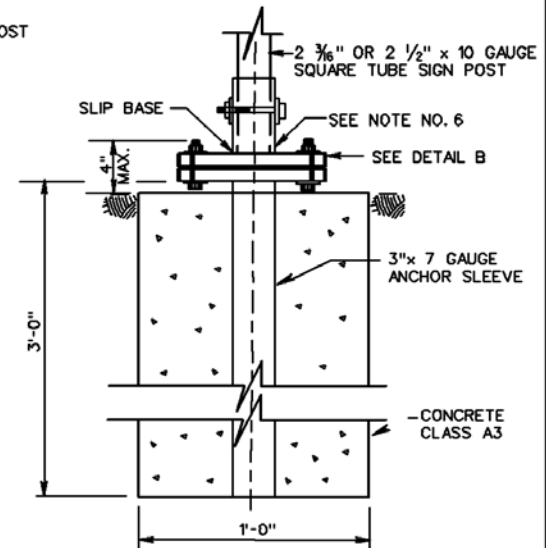

SIGN POST TO BE INSTALLED ON SLIP BASE IN ACCORDANCE WITH MANUFACTURERS RECOMMENDATIONS

SIGN PANEL ATTACHMENT DETAILS

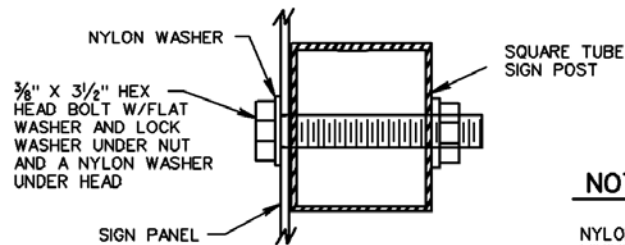

NOTES:

NYLON WASHER SHALL BE 1/16" THICK MINIMUM WITH AN OUTSIDE DIAMETER OF 1" AND AN INSIDE DIAMETER OF 7/16".

TOP OF SIGN PANEL SHALL BE FLUSH WITH THE TOP OF THE POST.

SIGN PANEL DESIGN SHALL BE IN ACCORDANCE WITH STANDARD SPD-5.

CORNER BOLT



CORNER BOLTS SHALL BE 5/16" DIA. CARRIAGE HEAD BOLT WITH SERRATED FLANGE NUT.

CORNER BOLTS SHALL BE USED FOR ATTACHING THE SQUARE TUBE SIGN POST TO THE ANCHOR SLEEVE OR SLIP BASE.



ROAD AND BRIDGE STANDARDS

SHEET 2 OF 3

REVISION DATE

1321.11

SQUARE TUBE SIGN POST

VIRGINIA DEPARTMENT OF TRANSPORTATION

SPECIFICATION REFERENCE

700

Virginia Test Method – 123

Post Installation Inspection of Buried Storm Drain Pipe and Pipe Culverts

June 25, 2010

SCOPE

For all roadway projects that are constructed by private contractors for VDOT and for all roadway projects constructed by others that are or will be proposed to be accepted into the VDOT highway system, a visual/video camera post installation inspection is required on all storm sewer pipes and for a selected number of pipe culverts in accordance with the instructions contained in this VTM and Section 302.03 of the VDOT Road and Bridge Specifications. The video camera inspection is to be conducted with a VDOT representative present.

The inspection can be conducted manually if adequate crawl/walking space and ventilation is available to safely conduct the inspection and the individual(s) conducting the inspection have undergone training on working in confined spaces in accordance with VDOT's current Safety Policy and Procedure #8 Confined Space Entry Policy and Procedure - General, or the inspection can be conducted with a video camera. If the inspection is to be conducted with a video camera, the video camera shall have fully articulating lenses that will provide a 360 degree inspection of the pipe/culvert, including each joint and any deficient areas of the pipe/culvert, as well as a means to measure deformations/deflections of the pipe (items such as a laser range finder or other appropriate device for taking such measurements as specified herein and approved by the Engineer).

If the inspection is conducted manually, the person performing the inspection may use a standard video camera or a digital camera to document any observed deficiencies. If the mandrel test is to be performed to mechanically measure deformations/deflections of the pipe/culvert, the mandrel used shall be a nine (or greater odd number) arm mandrel, and shall be sized and inspected by the Engineer prior to testing. The diameter of the mandrel at any point shall not be less than the allowable percent deflection of the certified actual mean diameter of the pipe or culvert being tested. The mandrel shall be fabricated of metal, fitted with pulling rings at each end, stamped or engraved on some segment other than a runner with the nominal pipe/culvert size and mandrel outside diameter. The mandrel shall be pulled through the pipe or culvert by hand with a rope or cable. Where applicable, pulleys may be incorporated into the system to change the direction of pull so that inspection personnel need not physically enter the pipe, culvert or manhole.

A copy of the Storm Sewer/Culvert Inspection Report (inspection report) including any video tape/Digital Video Recording (DVD)/digital photographs shall be provided to the VDOT Inspector within two business days of the completion of the inspection and made part of the project records. Additionally, a copy shall be furnished to local VDOT Asset Management personnel to document the pipe/culvert condition at that point in time. The video tape/DVD/digital photographs should be of such clarity, detail and resolution as to clearly show the conditions of the interior of the pipe/culvert and detect any defects within the pipe or culvert as specified herein. Post installation inspections shall be conducted no sooner than 30 days after completion of installation and placement of final cover (except for pavement structure).

PROCEDURES

The post installation inspection shall be conducted in accordance with the requirements of Section 302.03(d) of the Road and Bridge Specifications and the instructions included herein. The inspection

report shall identify the location of the pipe/culvert being inspected with respect to the project site. The inspection report shall identify the location of the inspection access point of the pipe/culvert being inspected with respect to the plans (e.g., north/south/east/west end of the pipe/culvert, manhole/drop inlet/junction box structure number, etc.). The location of any deficiencies within the pipe/culvert shall be noted in the inspection report by identifying the distance from the inspection access point. If no deficiencies are noted, an "OK" entry shall be made in the report under the remarks column for each section of pipe/culvert inspected.

Where deficiencies are found, a video recording is to be used to identify the deficiency in addition to it being noted on the report form. The video camera system shall be capable of capturing clear images. The camera system shall have a titler/keyboard for data entry and an audio microphone for verbal descriptions; both a textual note on the video/images and a verbal description shall be used to note deficiencies. The camera system shall have a locator system for locating the position of the camera, and a footage counter on the cable reel. The location and description of the deficiency should be added to the recording by the use of an audio microphone. When deficiencies are noted that require remedial actions, the contractor's proposed remediation measures shall be noted in the report form.

The Department shall review the post construction inspection report including any proposed remediation measures and communicate its findings to the Contractor within 10 days of receiving the report. Where the Department agrees with the proposed remediation measures, the contractor shall be notified of such approval and authorized to begin such work. Where the Department disagrees with the proposed remediation measures or where the Department identifies additional deficiencies that require remedial action, the contractor shall be notified of such findings and requested to submit a supplemental remediation plan. Pipes or culverts that required coating should have the coating inspected. Cracks (longitudinal and circumferential) shall be noted in the inspection report and photographed (if not videoed) and digitally scanned to allow for accurate measurement. Spalls and slabbing locations shall be photographed (or videoed) and noted in the report.

Upon completion of the corrective measures, the remedial locations are to be re-inspected prior to final acceptance of the project by the same test methods noted herein. Re-inspection shall be made within 10 days of correction except where sections of pipe/culvert have been replaced re-inspection shall not occur sooner than 30 days after replacement of pipe/culvert and final cover (except for pavement structure).

DEFICIENCIES

Deficiencies may include, but are not limited to, the following:

1. Crushed, collapsed or deformed pipe/culvert or joints.
2. Alignment defects would include sags in the longitudinal profile and invert heaving.
3. Improper joints that can allow leaking of water or infiltration of backfill or surrounding soils.
4. Misaligned joints that can cause debris accumulation.
5. Pipe/culvert that has been penetrated by guardrail or other posts or improper backfill materials or methods.
6. Debris, construction or other materials in the pipe/culvert or structures.
7. Coating material shall be free of cracks, scratches and peeling.
8. Cracks (longitudinal and circumferential).
9. Spalls and slabbing.
10. For metallic and plastic pipes/culverts, localized buckling, bulging, cracking at bolt holes (metallic only), flattening, or racking, as well as the applicable points noted above.

REPORTS

The attached form is to be used to report the inspection findings. Proposed remedial actions, if required, can be attached on separate pages.

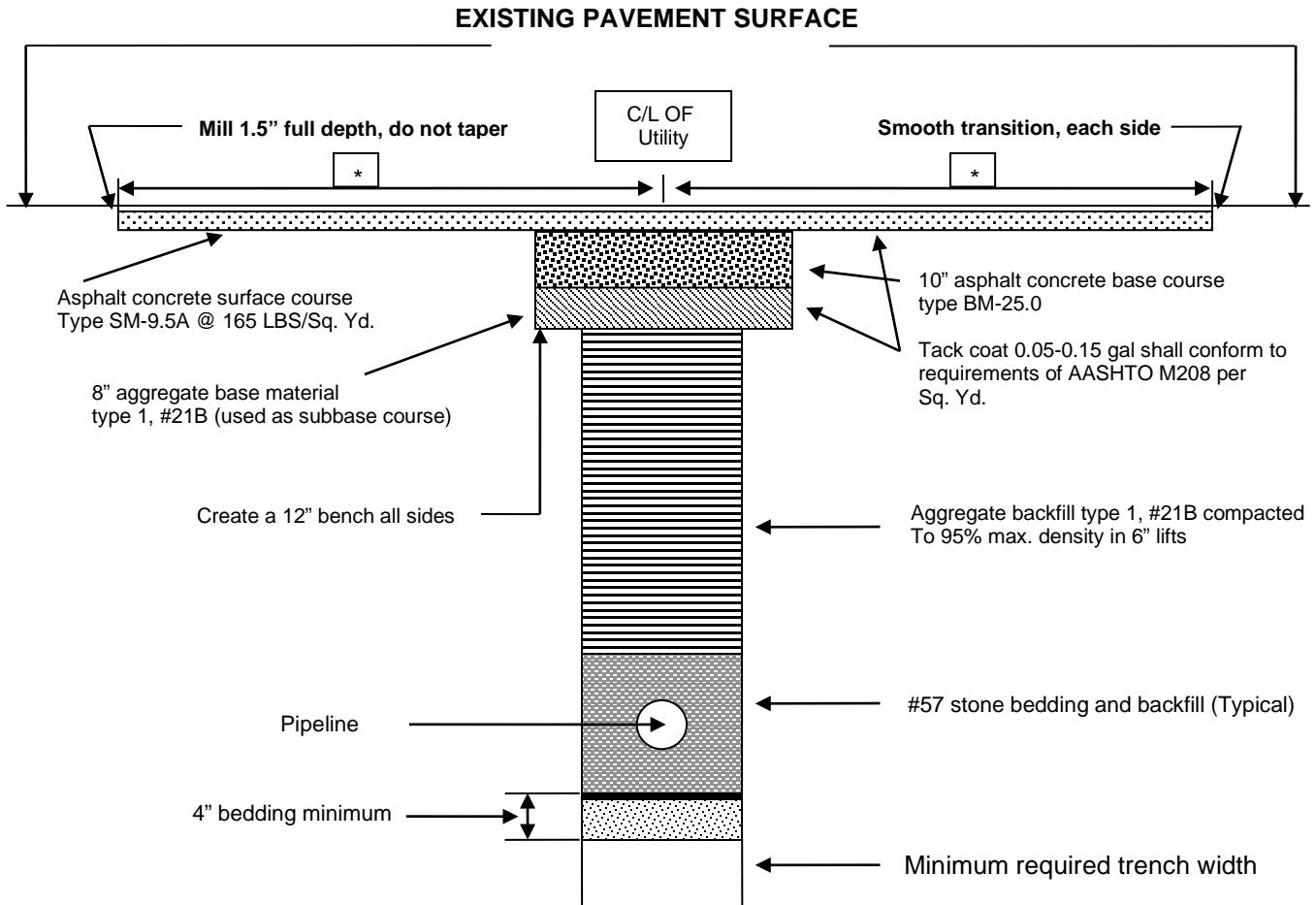

Not to Scale

Notes: All pavement markings damaged or destroyed by trench excavation activity shall be replaced by the permittee in accordance with current VDOT Standards & Specifications. This detail applies to highways with existing asphalt pavement sections. The extent of pavement restoration for all other pavement types shall be determined by the District Administrator's designee.

* Width of travel lane; minimum full pavement width restoration for open cut trenching along road centerline or 25' (minimum) for perpendicular crossings



COMMONWEALTH of VIRGINIA

DEPARTMENT OF TRANSPORTATION
4975 Alliance Drive
Fairfax, VA 22030
(800) 367-ROAD (7623)

GREGORY A WHIRLEY
COMMISSIONER

March 22, 2012

MEMORANDUM

TO: Prince William County Staff

FROM: Art Klos
Permit Manager

SUBJECT: Subordination of Rights Agreement

The attached Subordination of Rights Agreement has been in effect since 2009. This document is to be used in place of quitclaim deeds in all situations where a new street crosses a gas or petrochemical product transmission line or distribution line.

When this document is executed and accepted, it satisfies the quitclaim requirements of the 2005 Subdivision Street Requirements, 2009 Secondary Street Acceptance Requirements, and 2011 Secondary Street Acceptance Requirements.

Please direct any questions concerning this document to the Prince William Permit office.

Attachment

Subordination of Rights Agreement

(For new public roads intended for maintenance by the Department of Transportation)

THIS AGREEMENT, made and entered by and between _____, a Virginia corporation (hereinafter “GRANTOR”), and the local government of the county or town named herein, and the Commonwealth of Virginia, Department of Transportation (each hereinafter a “GRANTEE” and collectively “GRANTEES”);

WITNESSETH:

WHEREAS, the GRANTOR has permitted a motor vehicle road and road right of way, inclusive of other ancillary public use facilities (sidewalks, etc.), all hereinafter called “roadway,” to cross and coexist with a right of way easement GRANTOR holds for constructing, maintaining, operating, altering, repairing, inspecting, protecting, removing, and replacing certain natural gas or petrochemical transmission line(s) or distribution line(s), or both, that it operates; and

WHEREAS, the GRANTOR and GRANTEES mutually recognize the needs of the other, their respective roles, and find it desirable to cooperate in the shared use of the land in a manner that ensures the rights of the GRANTOR and the travelling public are adequately protected and public safety is assured;

NOW THEREFORE, for and in consideration of the sum of one dollar (\$1.00), cash in hand paid, receipt of which is hereby acknowledged, and subject to the terms, conditions and reservations set forth hereinafter, the GRANTOR, hereby agrees that it’s rights shall be subordinate to the surface transportation rights of the citizens of the Commonwealth to use the roadway, represented by the GRANTEE or such other public road officials as may have jurisdictional authority over the public roadway to the extent the public roadway co-exists with the GRANTOR’s easement, defined as that part of its easement crossing or encroaching within the right of way of (street name) _____, located approximately _____ miles from its intersection with the nearest existing State Route (#____), and situated in (name of subdivision) _____, in (name of County or Town) _____.

Subject to the terms and conditions hereof, the GRANTOR reserves unto itself, its successors, and assigns all of the rights and privileges established under its easement, granted the ____ day of _____, _____, and filed in the clerk’s office of the Circuit Court of _____ County, Virginia; indexed as instrument _____ or recorded in Deed Book _____ at page _____ (the “Easement”).

The subordination herein granted shall become effective at such time as GRANTEES have accepted this document and the Virginia Department of Transportation has issued a remain in place Land Use Permit to the GRANTOR for its facilities, it being mutually agreed that the issuance thereof shall be subject to the following provisions and conditions which shall be deemed incorporated therein and which shall be covenants running with the land under the terms of this instrument:

1. The GRANTOR’S facilities within the area defined above may continue to occupy the roadway in their existing condition and location, free of charge.
2. The GRANTOR hereby agrees:
 - a. To notify the Department or entity having jurisdiction over the roadway of its work events prior to their initiation, except as may be required under emergency situations, and to obtain appropriate prior authorization addressing the work to be performed within the public transportation right of way authorized by a VDOT issued Land Use Permit or such other permission or document required by an entity other than the Department having jurisdiction over said roadway and, in the event of emergency situations, to obtain said authorization as soon as possible.

- b. That GRANTOR shall at all times indemnify and save harmless the Commonwealth of Virginia, Department of Transportation, its employees, agents, and officers (or the same representing such other entity having jurisdiction over the roadway) from any responsibility, damage or liability whatsoever arising from GRANTOR'S maintenance and construction of its facilities within the roadway.
3. In the event that either GRANTEE requests relocation, alteration or modification of GRANTOR's facilities within the roadway, such GRANTEE shall bear the total nonbetterment cost of such relocation, alteration or modification; and each GRANTEE specifically waives any right or provision to the contrary contained in the standard form utility permit or otherwise. For purposes of this agreement, "total nonbetterment costs" is defined as the total cost of relocating, altering or modifying facilities with capacity and maximum pressure design characteristics comparable to those design characteristics of the facilities existing at the time of this agreement. In the event a GRANTEE requires such relocation, alteration and/or modification and GRANTOR wishes to replace the facilities at that time with upgraded facilities of greater design characteristics, GRANTOR shall pay such incremental costs as are attributable to the upgrade of facilities.
 4. The GRANTEE, or a subsequent governmental entity having jurisdiction over the roadway, is to have and hold the roadway property described herein with the benefit of the subordination herein granted for so long as said property is maintained and used as a public street or highway open to the travelling public, but upon abandonment of said roadway, all rights, privileges, interests and easements of GRANTOR in and to the roadway property established under the aforesaid Easement filed in the Clerk's office of the Circuit Court shall revert and restore to the GRANTOR, its successors and assigns, free from such subordination of GRANTOR's rights and the subordination herein granted shall automatically terminate and become null and void without the necessity of any further action or writing; and, in such event, GRANTEES shall, upon being requested in writing to do so by GRANTOR, its successors and assigns, promptly execute and deliver to GRANTOR, free of charge, an appropriate document, in suitable form for recording in the aforesaid Clerk's office, which confirms the termination, surrender and release of the subordination herein granted.
 5. In the event of a conflict or inconsistency between the terms and conditions of this instrument and those contained in any permit, authorization or other document issued or executed by the parties hereto, their successors and assigns, with respect to GRANTOR's facilities located in the roadway or work thereon, the terms and conditions of this instrument shall govern.
 6. This instrument shall be binding upon and accrue to the benefit of the GRANTOR and the GRANTEES, and each of their respective successors and assigns.

IN WITNESS WHEREOF, the GRANTOR causes its name to be assigned hereto by its appropriate office, all after due authorization, to become affective as of the date accepted and signed by duly authorized officers of the local government and the Department.

GRANTOR: _____

By: _____
 (Name and Title) Date

COMMONWEALTH OF VIRGINIA, CITY/COUNTY OF _____, to wit:

(Name) _____, acknowledged the foregoing instrument before me this _____ day of _____, _____.

NOTARY PUBLIC Notary registration number
My commission expires: _____

GRANTEES: _____ (Name of Local Government)

ACCEPTED _____ Date _____
(Name and Title of Authorized Local Government Official)

ACCEPTED _____ Date _____
(VDOT Commissioner, Maintenance Division Administrator,
or Authorized Official)

COMMONWEALTH OF VIRGINIA, CITY/COUNTY OF _____, to wit:

(Name) _____, acknowledged the foregoing instrument before me this _____ day of _____, _____.

NOTARY PUBLIC Notary registration number
My commission expires: _____

COMMONWEALTH OF VIRGINIA, CITY/COUNTY OF _____, to wit:

(Name) _____, acknowledged the foregoing instrument before me this _____ day of _____, _____.

NOTARY PUBLIC Notary registration number
My commission expires: _____

**COMMONWEALTH OF VIRGINIA
DEPARTMENT OF TRANSPORTATION**

MANUAL OF INSTRUCTIONS - MATERIALS DIVISION

SECTION 116 MATERIALS TESTING REQUIREMENTS

Sec. 116.01 Personnel Qualifications

Materials testing will be performed by trained and qualified technicians/inspectors. A trained and qualified technician/inspector is defined as a person that holds a current valid certification through the respective Materials Certification Program. Technicians/inspectors and other Department personnel conducting acceptance tests not covered by a Materials Certification Program will perform testing in accordance with general guidance from the appropriate responsible District or Central Office Program Manager.



COMMONWEALTH of VIRGINIA

DEPARTMENT OF TRANSPORTATION

4975 Alliance Drive
Fairfax, VA 22030

GREGORY A WHIRLEY
COMMISSIONER

March 26, 2012

Mr. Tom Blaser
Director of Transportation
County of Prince William
5 County Complex Court Suite 290
Prince William, Va. 22192

Subject: Phased Construction of Subdivision and Secondary Streets

Dear Mr. Blaser,

We have recently reviewed the Department's policy on phased construction of subdivision and secondary streets in the Northern Virginia District. As before, phased construction is acceptable provided no more than 10 percent of the intermediate/base course required patching prior to placement of the final surface course. Streets which require more than 10 percent of the intermediate/base course to be patched must be completely replaced to adequately repair the deficient pavement layer, if necessary to subgrade elevation.

While current practice is to place the intermediate/base course early on in the construction process and then allow construction traffic over the partially constructed pavement, adequate attention must be paid to these heavy loadings during design to prevent premature failure of pavements which are exposed to construction traffic over extended periods of time. Although the intent of this phased construction is to prevent damage to the final surface during construction, the Northern Virginia District recommends that a maximum exposure limits of 2 years should be placed on phased construction to prevent premature deterioration of the partially constructed pavements.

As always we are striving to achieve a high quality and long lasting pavement structure without imposing an undue financial burden on the development community and we appreciate your support. If you have any questions, please do not hesitate to call me at (703) 259-1998.

//Original signed//

David P Shiells, P.E.
District Materials Engineer

cc: Art Klos
Maria Sinner, P.E.
Alexandra Tuliszka, P.E.

VirginiaDOT.org
WE KEEP VIRGINIA MOVING

Clarification of staged surfacing of subdivision and secondary streets

DCSM 602.11

- H.** For staged construction, two and one-half (2-1/2) inches shall be the maximum thickness of the bituminous concrete surface (SM-9.5A or SM-9.5D). The thickness of each lift shall be of one and one quarter (1-1/4 inches).

- I.** If staged construction is performed, a four (4) foot radius area, measured from the center of the manhole cover around protruding utility manholes, shall be paved with leveling asphalt concrete surface mix (SM-9.5A) to provide a relatively smooth riding surface. In addition, the asphalt concrete paved peripheries shall be painted with twelve (12) inch wide white colored paint acceptable to County inspectors. The maximum exposure limit for staged construction shall be two (2) years, unless it is extended by the director of Transportation.



COMMONWEALTH of VIRGINIA

DEPARTMENT OF TRANSPORTATION
4975 Alliance Drive
Fairfax, VA 22030
(800) 367-ROAD (7623)

GREGORY A WHIRLEY
COMMISSIONER

March 22, 2012

Doug Wilson
Prince William County Department of Transportation
5 County Complex Court Suite 290
Prince William, Va. 22192

Re: Accepting Streets with Outstanding Violations

Dear Mr. Wilson,

VDOT and Prince William County reached an agreement in 1996 regarding developers who failed to take corrective action to address violations issued for not meeting VDOT and County road construction specifications and requirements. As agreed, VDOT will accept streets into State Secondary System with an outstanding violation providing the following conditions are met:

If the violation is determined by the County and VDOT to be minor (the future safety and integrity of the roadway and its appurtenances is not considered at risk), the developer will be required to post a three year warranty bond with the County. The amount of the warranty bond will be determined according to VDOT and County. If the developer does not obtain a warranty bond, VDOT will not accept the street into the State Secondary System.

If the violation is determined by the County and VDOT to be major (the future safety and integrity of the roadway and its appurtenances is considered at risk), the developer's entire road construction bond for the street in question or ten percent of the total construction bond for the development (whichever is greater) will be held by the County for five years to insure the future safety and integrity of the street. A copy of the violation will be sent to the developer's bonding/surety company.

Please be advised the VDOT staff is available to meet and review outstanding violations upon request.

Sincerely,

A handwritten signature in cursive script that reads "A. G. Klos".

Art Klos
Prince William Permit Manager



COUNTY OF PRINCE WILLIAM
DEPARTMENT OF PUBLIC WORKS

Environmental Services Division
Watershed Management Branch
5 County Complex Court, Suite 170, DS-930
Prince William , Virginia 22192-5308
Main (703) 792-7070 Facsimile (703) 792-6297

FEE SCHEDULE

Effective July 1, 2020

PLAN REVIEW

Lot Grading - New Submission or Major Revision	\$458.95/LOT
Lot Grading - Minor Revision	\$ 59.06/LOT
Geotechnical Study Review /Lot	\$165.78/LOT
As-Built - First Submission (After Meeting with Site Inspector)	\$369.12
As-Built - Second Submission Fee (One-Time Fee)	\$301.45

SITE INSPECTION

Camera Van Inspection (minimum fee \$280.00)	\$ 2.33/L.F.
Camera Van Re-inspection Fee	\$280.00
Erosion & Sediment Control Variance	\$355.58
Lot Grading Inspection (Paid with Building Permit)	\$228.86
Lot Grading Re-Inspection Fee (Must be Paid Prior to Rescheduling)	\$ 95.97
Occupancy Phasing Plans	\$ 99.71/PHASE
Occupancy Site Inspection Request (Commercial / Multi-family)	\$141.75/BUILDING

RPA & WETLANDS

Administrative Exception (Primary structure)	\$165.78
Administrative Exception (Accessory structure)	\$ 84.09
Public Hearing Exception (thru ChesBay Pres. Area Review Board)	\$785.02
Appeal to Chesapeake Bay Preservation Area Review Board	\$766.41
Wetlands Permit Application	\$603.56

WATERSHED RELATED FEES - PAID AT LAND DEVELOPMENT OFFICE

Land Disturbance Permit	\$ 125.50
Waiver Requests by Individual Lot Owners	\$169.80

ADMINISTRATIVE

Returned Check Fee	\$ 50.00
--------------------	----------



**COUNTY OF PRINCE WILLIAM
DEPARTMENT OF PUBLIC WORKS**

*Environmental Services Division, Watershed Management Branch
5 County Complex Court, Suite 170, Prince William, Virginia 22192
(703)792-7070 Metro 631-1703, Ext. 7070 Fax(703)792-7012*

Inspections / Right-Of-Entry Notice

PROJECT NAME: _____

PROJECT ADDRESS: _____

State Laws, State Regulations, and Prince William County Codes require that inspections be conducted on various projects.

Inspections are required by the owner/permittee/their authorized agents **AND** by Prince William County staff.

Application for, and acceptance of, any of the various permits required by these laws, regulations, and codes, provides right of entry to your site for authorized personnel to conduct those inspections.

Inspections by Prince William County staff will be conducted during normal business hours. Any time that an activity is occurring at the site is deemed to be “normal business hours”.

In the event of an emergency, imminent or actual threat to safety, health, or environment, inspections may be conducted at any time.

This document is notice that Prince William County Staff will conduct inspections for the duration of your project. No further notice will be given.

Owner Name (Print)

Permit Holder (Print)

Owner Signature Date

Permittee Signature Date

Phone

Phone

Address

Address



**COUNTY OF PRINCE WILLIAM
DEPARTMENT OF PUBLIC WORKS/
DEPARTMENT OF TRANSPORTATION**

Site Inspections

*5 County Complex Court, Prince William, Virginia 22192
(703)792-7070 Metro 631-1703, Ext. 7070 Fax(703)792-7012*

PROJECT INSPECTION OVERVIEW

This document is intended to provide the developer/land disturber with an overview of information pertaining to the inspection requirements for projects in Prince William County and is by **NO MEANS** all inclusive. With this information you will be more aware of the requirements for inspections, documentation, and final inspections which should help to make the land development process as smooth as possible. This document is **NOT** intended to replace any county or state requirements. A set of **APPROVED** plans and a developer's representative shall be made available to the inspector on the site at all times during normal business hours.

A. INSPECTIONS

1. The developer must notify the site inspector **at least 24 hours in advance** before commencing any new operations, i.e. storm pipe installation, placement of concrete, aggregate, asphalt, etc.
2. Call the Site Inspector when the project's clearing limits have been flagged and are ready to be inspected.
3. After the clearing limits have been approved by the inspector, initial clearing may commence for installation of the Phase 1 Erosion and Sediment controls, including tree protection. The Site Inspector may add or delete controls in the field. Major deviations from the approved plan require a written, approved variance.
4. When the E&S controls are approved by the Site Inspector(s), he/she will sign off on the permit and the remaining site clearing can commence. Inspections are required for any stripping of topsoil, grading, excavation, fill, embankment, landscaping and buffers.
5. Inspections are required for construction of SWM/BMP facilities.
6. **PRIOR APPROVAL FROM THE SITE INSPECTOR IS REQUIRED FOR REMOVAL, MODIFICATION OR CONVERSION OF E&S CONTROLS, BASINS, AND TRAPS.**
7. Installation of storm drainage systems shall conform to all applicable DCSM and VDOT specifications. Prior to installation the inspector must have in hand certified cut sheets from a licensed surveyor or P.E. The cut sheets **MUST** include the following statement:

“The professional seal and signature appearing on this document certifies that the information shown conforms to the approved plan and/or actual field conditions. Minor deviation for the approved plan shall be performed in a manner comparable to the original design and shall meet all applicable standards.”

These cut sheets may be faxed to the Site Inspector's attention at 703-792-7012.

8. **STORM SEWERS WILL BE TV'D BY PWC.**
9. Storm sewers **MUST** be inspected and **APPROVED BEFORE** final paving.

B. OCCUPANCIES

Commercial:

1. Developer's representative must fill out a Site Inspection Request form and pay an associated fee. Upon receipt of a Site Inspection Request, the Site Inspector will contact the developer's representative and schedule the occupancy inspection.
2. A certified impervious area worksheet will be required as part of the inspection.
3. The approved site inspection is necessary to obtain the Certificate of Occupancy.
4. Landscape buffers **MUST** be in place.

C. PHASING:

Commercial and town house projects may be phased. Common areas **MUST** be included in the phasing plan. All work in a given phase must be completed in order to receive an Occupancy Permit. Frontage requirements and SWM **MUST** be included in the first phase. The Site Inspectors will explain aspects of phasing as needed.

D. STORM EASEMENTS

ALL obstructions MUST be removed from stormwater easements. This includes, but is not limited to, trees, shrubs, phone and cable boxes, etc. Fences may be permitted with prior approval from Zoning and Watershed Management.

E. SITE FINALS, GENERAL REQUIREMENTS

Most projects will require as-built drawings. One (1) set of as-built drawings and one (1) recorded plat is to be provided to the Site Inspector for a preliminary review; for commercial sites an Impervious Area calculation is also required. If the Site Inspector approves the preliminary review a transmittal form will be issued to the developer/owner or their authorized representative. The as-built, Impervious Area calculation and signed transmittal form are to be taken to the Watershed Management office for a complete review. Upon approval by the Watershed Management engineers five (5) sets of drawings and recorded plats, along with a compact disk containing an as-built plan in .TIFF format will be required. All become the property of Prince William County.

If the streets are to be accepted into the VDOT system, **VDOT acceptance must take place before the PWC final** inspection. Upon VDOT acceptance, the site will be walked by the Site Inspector one more time to note any deficiencies. If all deficiencies are corrected within thirty (30) days or less, the site final can be recommended. If not corrected within the 30 days, the walk and inspection process must be repeated.

PW Service Authority and VDOT, as appropriate, must sign off on all improvements and any **proffer conditions** must be met before Bond Administration will release any funds.



DATE: _____

PROJECT NAME: _____

PROJECT NUMBER: _____

The Responsible Land Disturber (RLD) for this site is:

Certification Number: _____ Expires: _____

RLD Reports are due to Watershed Management the 1st & 15th of the month beginning after erosion release and continuing until site stabilization. They may be faxed to the inspector's attention at: 703-792-7012.

AFTER HOURS EMERGENCY CONTACT

NAME: _____ PHONE: _____

The developer agrees to notify Watershed Management in writing if the RLD or the after hours emergency contact changes.

The owner or his designated representative agrees to obtain all applicable environmental Federal and State permits. These include:

- Wetland permits (SPGP (Federal); VWPP (State))
- Stream Impact permits (SPGP, VWPP)
- VSMP (construction, discharge permits)
- Hazardous Materials/Waste permits
- Other applicable permits for type of use industry

In accordance with the DCSM (741.01 (I)), "Prior to issuing a permit that allows any type of land disturbance, related to a final site and subdivision plan all wetland permits required by federal, state, and local laws and regulations shall have been obtained and evidence of such submitted to the County." The owner agrees to provide the Site Inspector with copies of all Federal and State permits and approved plans prior to the commencement of work.

ANY VIOLATIONS ISSUED DURING THE COURSE OF CONSTRUCTION WILL NEGATE ALL BOND REDUCTION REQUESTS UNTIL SITE IS FINALED. THIS ALSO SERVES AS NOTICE THAT INSPECTIONS WILL BE CONDUCTED AT ANY TIME DURING NORMAL BUSINESS HOURS UNTIL SITE FINAL, AND THAT AN APPROVED SET OF PLANS ARE REQUIRED ON SITE FOR INSPECTOR USE.

This is to certify that I (we) have read and understand the information in this packet.

DATE

DATE



Daily Fill Observation Report

This report should be e-mailed, mailed or hand delivered within five (5) days from the test date to the address below for proper distribution:

Prince William County
Department of Public Works
Environmental Services Division
5 County Complex Court Suite 170
Prince William, VA 22192

Attn: LISA COLLETTI (LColletti@pwcgov.org)

Please be advised that as stated in the notes of the Daily Fill Observation Report Form: A copy of the daily fill observation report with required attachments should be submitted within five (5) business days from the test date to the address above.

Please update all addresses before sending the report. If the engineered fill is being placed for building pads with a building permit, then the daily fill observation report should also be submitted to the Building Division.

For questions or concerns, please contact: Lisa Colletti, PWC DPW ESD Direct: (703) 792-6691 or main phone# (703) 792-7070.

Thank you.



PRINCE WILLIAM COUNTY
DEPARTMENT OF PUBLIC WORKS
5 County Complex Court, Suite 170 - Prince William, Virginia 22192-5308
 (703) 792-7070 Metro 631-1703 FAX: (703) 792-7012

BI-WEEKLY RESPONSIBLE LAND DISTURBER (RLD) REPORT

DATE INSPECTED: _____

PLAN #: _____

PROJECT NAME: _____

PHASE: _____ SECTION: _____

STAGE OF CONSTRUCTION

____ Pre-Construction Conference
 ____ Clearing and Grubbing

____ Rough Grading
 ____ Building Construction

____ Finish Grading
 ____ Final Stabilization

YES NO N/A

- | | | | | |
|--------------------------|--------------------------|--------------------------|---------------|--|
| <input type="checkbox"/> | <input type="checkbox"/> | <input type="checkbox"/> | * MS-1 | Are there any denuded areas which require temporary or permanent stabilization? |
| <input type="checkbox"/> | <input type="checkbox"/> | <input type="checkbox"/> | MS-2 | Are soil stockpiles adequately stabilized with seeding and/or sediment trapping measures? |
| <input type="checkbox"/> | <input type="checkbox"/> | <input type="checkbox"/> | MS-3 | Does permanent vegetation provide adequate stabilization? |
| <input type="checkbox"/> | <input type="checkbox"/> | <input type="checkbox"/> | MS-4 | Have sediment trapping facilities been constructed as a first step? |
| <input type="checkbox"/> | <input type="checkbox"/> | <input type="checkbox"/> | MS-5 | Are perimeter sediment trapping measures in place and earthen structures seeded and mulched? |
| <input type="checkbox"/> | <input type="checkbox"/> | <input type="checkbox"/> | MS-6 | Are sediment basins installed where needed? |
| <input type="checkbox"/> | <input type="checkbox"/> | <input type="checkbox"/> | MS-7 | Are all cut and fill slopes adequately stabilized? |
| <input type="checkbox"/> | <input type="checkbox"/> | <input type="checkbox"/> | MS-8 | Are there paved flumes, channels, or slope drains where necessary? |
| <input type="checkbox"/> | <input type="checkbox"/> | <input type="checkbox"/> | MS-9 | If water is seeping from a slope face, has adequate drainage or other protection been provided? |
| <input type="checkbox"/> | <input type="checkbox"/> | <input type="checkbox"/> | MS-10 | Are all operational storm sewer inlets protected so that sediment will not enter the system? |
| <input type="checkbox"/> | <input type="checkbox"/> | <input type="checkbox"/> | MS-11 | Are stormwater conveyance channels adequately stabilized with channel lining and/or outlet protection? |
| <input type="checkbox"/> | <input type="checkbox"/> | <input type="checkbox"/> | MS-12 | Is in-stream construction being conducted using measures to minimize channel damage? |
| <input type="checkbox"/> | <input type="checkbox"/> | <input type="checkbox"/> | MS-13 | Are temporary stream crossings of non-erodible material installed where applicable? |
| <input type="checkbox"/> | <input type="checkbox"/> | <input type="checkbox"/> | MS-14 | Have all applicable federal, state, and local regulations pertaining to working in or crossing live watercourse been met? |
| <input type="checkbox"/> | <input type="checkbox"/> | <input type="checkbox"/> | MS-15 | Is necessary restabilization of in-stream construction complete? |
| <input type="checkbox"/> | <input type="checkbox"/> | <input type="checkbox"/> | MS-16 | Are utility trenches being backfilled, seeded, and dewatered properly? |
| <input type="checkbox"/> | <input type="checkbox"/> | <input type="checkbox"/> | MS-17 | Is there any evidence of mud on public roads at intersections with access roads? |
| <input type="checkbox"/> | <input type="checkbox"/> | <input type="checkbox"/> | MS-18 | Are there any structural practices that should be removed because they are no longer needed? |
| <input type="checkbox"/> | <input type="checkbox"/> | <input type="checkbox"/> | MS-18 | Do any structural practices require repair or clean-out to maintain adequate function? |
| <input type="checkbox"/> | <input type="checkbox"/> | <input type="checkbox"/> | MS-19 | Are properties and waterways downstream from development adequately protected from E&S due to increases in peak stormwater runoff? |

* Refers to the minimum standards of the Virginia Erosion and Sediment Control Regulations (VR 625-02-00).

Required Corrections:

Are all perimeter controls installed and being maintained per the approved plans? **YES** **NO**

Does this site meet the minimum erosion and sediment standards of Prince William County's Design and Construction Manual? **YES** **NO**

RESPONSIBLE LAND DISTURBER (PLEASE PRINT)

RLD CERTIFICATION NUMBER

RLD SIGNATURE

DATE

DAILY FILL OBSERVATION REPORT

PWC- Project Name: _____ **Plan No:** _____
Permit No: _____ **Developer:** _____ **Report No:** _____
Contractor: _____ **County's Area Site Inspector:** _____
Date: _____ **Weather:** _____ **Temp:** _____ °F **Arrival:** _____ **Departure:** _____

Approved Plan on Site:
 Yes No

A copy of the County Approved Plan with the approved Geotechnical recommendations shall be on Site prior to and during any field activity. In addition, the Department of Public Works Area Site Inspector shall be informed prior to placement of engineered fill.

Source of Fill Material*:
 Onsite, Location: _____ Proctor #(s) *: _____ OMC*: _____
 Offsite, Location: _____ Proctor #(s) *: _____ OMC*: _____

Method of Compaction: Sheep foot Smooth Drum Others (Vibratory Plate/Rammer/Jumping Jack, Etc.)

Fill Material Meets Approved Specifications? <input type="checkbox"/> Yes <input type="checkbox"/> No	Blending, Mixing, or Stabilization Required? <input type="checkbox"/> Yes* <input type="checkbox"/> No	Type of Stabilization: <input type="checkbox"/> Lime* <input type="checkbox"/> Cement* <input type="checkbox"/> Mechanical Mixing*
--	---	---

Observed in fill soil:
 Mica CH-MH Marine Clay Organics Lime* Cement* Stone* Topsoil* Others* (Debris, etc.)

Test Location: (Detailed information under the test locations should be included in the field test reports) **Maximum loose lift thickness shall be no more than 8 inches.**

Building Pad Street/Parking Lot Utility/Infrastructure Embankment/Slopes (Pond, Retaining Wall)

Lot No(s): _____ **Street Name/ Location:** _____ **Total no. of lifts:** _____ **Start Grade:** _____ ft.
Station/Test reference points: _____ **End Grade:** _____ ft.

Unsuitable material in fill area? <input type="checkbox"/> Yes <input type="checkbox"/> No	Ground water encountered during construction? <input type="checkbox"/> Yes <input type="checkbox"/> No	(If yes, the Site Inspector must be informed prior to commencement of fill operations)
---	---	---

Remarks: _____

Notes:

- * Onsite refers to soil taken from another location in the same section/subdivision. Offsite refers to soil imported from outside the section/subdivision.
- ❖ A written approval shall be obtained from Prince William County prior to any blending/mixing or soil stabilization activities. A written approval is not required for air drying of soil or adding water to dry soils.
- ❖ Soil Stabilization refers to chemically or mechanically altering the soils to stabilize for Plasticity, and/or Moisture Content Reduction.
- ♦ Sketch showing testing locations, Lab report with Proctor, Optimum Moisture Content (OMC) and Atterberg Limits shall be attached to this report. For proctors repeated over several days, only reference the proctor # and last report reference under remarks.
- ♦ Two (2) copies of the Daily Fill Observation Report with required attachments shall be submitted within five (5) business days from the test date, to the Prince William County Department of Public Works - Watershed Management Branch at 5 County Complex Court, Suite 17□, to the attention of Area Site Inspector. If the engineered fill is placed for the building pads under a building permit, Daily Fill Observation Reports should be submitted to the Building Division.
- ◇ □□□□ Certification: Geotechnical Engineer's Field Representative shall have an active soil certification from WACEL, VDOT, NICET or Equivalent as approved by the Department of Public Works, Prince William County.

Signature and Seal:

The engineered (controlled/structural) fill has been placed in accordance with the approved plans and specifications.

Name of the Technician◊: _____
Certification From: _____
Certification Number: _____
Certificate Validation Period◊: _____



COUNTY OF PRINCE WILLIAM

DEPARTMENT OF PUBLIC WORKS

5 County Complex Court, Suite 170, DS-930

Prince William, Virginia 22192

(703)792-7070

Fax(703)792-7012

IMPERVIOUS AREA CALCULATION

Use one form per GPIN

PWC Plan Site Name: _____ Marketing Name _____

Land Permit Number: LND _____ PWC Plan Number _____

Site Address: _____

Site GPIN: _____ Occupancy Inspection Date: _____

The total impervious area (footprint) within the site (outside of any public right-of-ways) is _____ square feet. This includes all **new** paved areas such as driveways, parking areas, roofs, sidewalks, etc. This does not include areas with dirt or gravel surfaces.

Certified by:

Printed Name of P.E. or L.S.

Date

Signature

V.A. License #

Return this completed form to the address listed above.

Billing Info:

Account Number: _____

Previous Impervious Area: _____

Supplemental # _____ Year _____ SFEs: _____ \$: _____

Current Impervious Area: _____

Annual: Year _____ SFEs: _____ \$: _____

Total Impervious Area: _____

Information Verified: _____ Recorded by _____

Storm Billing Notes:

	Site Development Policies and Procedures Temporary Stockpiles	Effective Date: August 1, 2007
	Plan and Escrow Requirements	Supersedes Policy Dated: August 1994
		Issued By: <u>Original signed</u> Planning Director <u>Original signed</u> Director of Public Works

Intent:

This policy is meant to provide guidelines for the location and removal of stockpiles so that they do not become public nuisances or cause silt to be discharged into streams and waterways. It amends the existing policy that has been in place since August 1994.

The county recognizes the need to temporarily store fill material in active construction areas for Use elsewhere on-site in order to minimize the need for and cost of hauling away or importing fill. The county also recognizes that these storage areas can become nuisances if not closely monitored or allowed to remain in close proximity to occupied residential dwellings or major public roads.

Applicability:

This policy pertains to stockpiles (inclusive of topsoil, sand, rock, clay, stone and natural excavated materials) planned to be in existence for longer than six months on all residential projects and 12 months on commercial development projects. Mixed use projects are considered commercial projects for the purposes of this policy. Stockpiles shall not include construction trash or debris (inclusive of but not limited to concrete, asphalt, building materials, stumps and woody debris). **Temporarily stored materials and excavations that are being actively worked and in place less than six months on residential sites and 12 months on commercial or mixed use sites shall not be subject to this policy.**

Requirements:

1. Required Stabilization – Virginia Erosion and Sediment Control Law Standard and Specification 3.31 requires the establishment of a temporary vegetative cover on all disturbed areas that will not be brought to final grade for more than 30 days. In addition, until stabilized, appropriate erosion and sediment control measures, such as silt fences and perimeter controls, shall be installed and maintained.

2. Required Plan Submission – A temporary stockpile area may be approved as part of a site or subdivision plan or as a revision to an approved site or subdivision plan.
3. Location – The DCSM does not allow the clearing of areas in excess of that required to develop the site. Stockpiles will be allowed only in areas that are approved and deemed necessary to be disturbed for development. However, they will not be allowed in areas recorded as right-of-way, all utility easements, conservation easements, resource protection areas, flood plains, drainage divides, buffers, or where they interfere with vehicular sight distances.
4. Proximity to Residential – Stockpiles shall not be placed closer than 200’ from any existing occupied residential unit prior to land disturbance. New houses constructed within 200’ of an existing stockpile will not be issued occupancy permits unless proof of the buyer agreeing in writing to the stockpile location, or the stockpile is removed.
5. Slope and Height – Stockpiles may only consist of **on-site materials** taken from areas within the project limits as shown on approved and permitted plans. The maximum slope of stockpiles shall generally be 3:1 and with a height no greater than 35’ above average base elevation. At the request of the site inspector, an as-built plan shall be submitted to the Department of Public Works to ensure that the stockpile complies with these requirements.
6. Safety – Stockpiles not being actively worked within 14 days shall be surrounded by an Orange safety fence or silt fence or super silt fence as required by the site inspector.
7. Plan Validity – A temporary stockpile plan will remain valid so long as the development plan for the area where the stockpile is located is valid. If the development plan expires or the stockpile area is not developed in accordance with the approval plan, then any escrow posted for the stockpile may be used to restore the site to the satisfaction of Prince William County before the performance bond for the project is released.
8. Escrow for Erosion and Sediment Control – An escrow equal to the cost of removing 1/3 of the pile, re-grading and re-vegetation shall be included in the erosion control escrow. The escrow amount shall include current costs for transporting the stockpiles materials to the Prince William County landfill. The escrow posted shall be in the form of cash or letter of credit only. The escrow amount posted shall not be included in calculating the 50% minimum escrow retained as described in the DCSM.



COUNTY OF PRINCE WILLIAM
DEPARTMENT OF PUBLIC WORKS
Environmental Services Division - Watershed Management Branch
5 County Complex Court, Suite 170, Prince William, Virginia 22192
Main: (703) 792-7070 Facsimile: (703) 792-6297

APPLICATION FOR CONSTRUCTION WITHIN A STORM DRAINAGE EASEMENT OR
CONSTRUCTION WITHIN A STORMWATER MANAGEMENT FACILITY EASEMENT (POND)
(Circle One)

I, _____ (owner), request permission from the Department of Public Works to install a
 _____ within the storm drainage easement OR within a stormwater
 management facility easement located at: _____.

I **certify** that I am the **owner** of the property and I understand and agree to the following approval conditions:

1. All construction will be located entirely within the property unless there is mutual agreement with adjacent property owners to allow encroachment onto their properties.
2. Construction activity or the type of materials used for construction will not impede the flow of water or cause water to pond on adjacent properties or right-of-ways.
3. Construction will not destroy or disturb any utility lines or pipes. It is my responsibility to inform utility companies (**Dial 811 for MISS UTILITY**) of the construction activity prior to the commencement of construction.
4. All required permits and approvals shall be obtained prior to construction.
5. I will be responsible for all repair or replacement costs for any structure that I build within the easement if County workers damage or remove portions of this structure while they perform repairs on or reconstruction of the storm drainage system or stormwater management facility.
6. I grant permission to Department of Public Works staff full access into and across any area of the property to get to the storm drainage easement or stormwater management facility if the construction activity hinders or prevents direct access from a public right-of-way to the easement.
7. I will ensure that these approval conditions will convey as a condition of any future ownership of this property.
8. I am responsible for verifying with the Zoning Office any setback or proffer requirements and with my Homeowner's Association for any covenant restrictions that may regulate the construction activity.
9. This approval pertains only to easement rights owned by or assigned to the County and administered by the Watershed Management Branch.
10. The property owner is responsible for any liability or damage associated with the project.

A copy of a survey plat or lot grading plan is attached showing the location.

Applicant (Print Name): _____ GPIN: _____

Owner: Yes _____ No _____ Telephone Number: _____

Signature of Applicant: _____ Date: _____

(Office Use Only)
)

Approved (Print Name): _____ Date: _____

Signature: _____ Telephone No.: (703) 792-7070



**COUNTY OF PRINCE WILLIAM
DEPARTMENT OF PUBLIC WORKS**

Environmental Services Division, Watershed Management Branch
5 County Complex Court, Suite 170, Prince William, Virginia 22192
Main (703) 792-7070 Fax (703) 792-6297

AS-BUILT SUBMISSION AND APPROVAL PROCESS

DCSM 110.11 As-Built Plans: As-Built plans shall be required on all currently valid final site development plans. The acceptance of As-Built plans shall be a prerequisite to final construction acceptance, bond release, and the issuance of a final certificate of use and occupancy.

**The developer/builder should schedule an onsite inspection with the site Inspector, geotechnical engineer of record, and site civil engineer / land surveyor to identify slopes that need to be surveyed, evaluated, and identify any potential issues well in advance of submitting the As-Built plans for review.*

Processing of the As-Built Plan

1. Confirm with the site inspector that the site work is at an acceptable stage for As-Built plan submission.
2. If allowed to proceed, arrange a meeting with the site inspector for quality control review of the As-Built package. The customer shall bring the following to the quality control review meeting:
 - Two (2) copies of the As-Built plan (one rolled for civil review, one rolled for geotechnical review)
 - One (1) copy of the Recorded Plat
 - One (1) copy of recorded Storm Water Management Facility Maintenance Agreement (if applicable)
 - Impervious Area Calculation Sheet (if applicable)
 - Completed As-Built submission checklist including all referenced items
3. Once the As-Built plans are ready for submission, the site inspector will provide a signed As-Built Acceptance transmittal for inclusion with the As-Built package.
4. The complete As-Built package should be delivered to the Watershed Management Branch office along with the appropriate fee for review. The transmittal form needs to include a customer point of contact. This is the person who will be notified when the As-Built is approved. The first time submission fee is **\$369.12**. An additional one-time fee for second submission review is **\$301.45**. Checks should be made payable to Prince William County. Watershed Management staff will process the payment and assign the As-Built plan a new number for review.

5. **The review time is 15 calendar days per submission.** Comments are accessible via the following link: <http://egcap.pwccgov.org/CAPSite/Public/Main> (and entering the As-Built plan number). The point of contact listed on the transmittal will be notified by phone or e-mail when the plan is approved.
6. Final submission shall include of five (5) sets of plans, five (5) sets of recorded plats and a compact disc (cd) containing a copy of the plan file (.tiff), electronic spreadsheet, unit price list and each storm facility shall be itemized.
7. After approval, the As-Built plan can be picked up by the point of contact at the Watershed Management Branch office. The point of contact listed on the transmittal will be notified by phone or e-mail when the plan is approved. A copy of the signed Approved As-Built Pick-Up Transmittal will serve as confirmation of receiving the approved As-Built plan.
8. After the final site walk, and prior to the bond release, the Site Inspector will accept 4 original sets of the approved As-Built plans and plats (and other documentation if any) from the Developer's representative. The Site Inspector will distribute the approved As-Built plan to the following agencies:
 - Watershed Management Branch
 - Planning Records
 - Geographic Information Systems
 - Real Estate Assessments

Intentionally blank

	Site Development Policies and Procedures	Effective Date: July 1, 2020
	Closed Circuit Inspection of Storm Sewer Systems	Supersedes policy dated: July 1, 2019
		Issued by: Marc T. Aveni Assistant Director of Public Works for Environmental Services

Prince William County Closed Circuit (CC) Inspection Process

1. A Closed Circuit (CC) Inspection of the entire storm sewer system documenting no deficiencies shall occur prior to obtaining final bond release for all residential and commercial projects.
2. Prior to application for CC Inspection, the project site must conform to conditions listed below; failure to have site ready for inspection will result in cancellation of the scheduled CC inspection. Minimum conditions include:
 - Base asphalt is laid down
 - Storm drainage systems flushed, cleaned, and free of debris
 - All storm structures are set to their final grades- inverts, steps, tops, and grates installed
 - All structures to be inspected must be marked in field (per approved plan) prior to inspection
 - All stormwater management facilities are accessible via camera van vehicle and to County staff
3. Once confirmation of the site's readiness for CC inspection has occurred, remit the items listed below to the Watershed Management Branch at the address in item #5:
 - Unmarked, full-size (24" x36") copies of the approved site plan to include the most current unit price list (UPL), most current cover sheet and **all** revisions related to storm drainage systems
 - Storm sewer profiles
 - Storm water management plan (if applicable)
 - Application for CC inspection
 - Applicable fees
4. For the most current fees, please refer to the PWC Land Development Fee Schedule at the following URL: <http://www.pwcgov.org/LDDFeeSchedule>.
 - The current fee is \$2.33 per linear foot for all areas to be inspected by County staff
 - **A separate CCTV Inspection Request Form and fee is required for each section and phase of a project, especially for large subdivision developments**
 - A minimum fee of \$280.00 will be assessed for inspection of storm easements totaling less than 250 linear feet

- Camera Van Re-inspection / Not Ready fee of \$280.00 (per request) will apply to any site requesting an inspection whose punch list items have not been corrected or the storm drainage system cannot be inspected / re-inspected due to inaccessibility, trash, debris, or standing water in the system. The re-inspection / not ready fee must be paid in advance of any additional inspections
5. Fees can be paid by cash, credit card, or check. Checks shall be made payable to “Prince William County” and can be remitted by mail or in person along with the items listed in item #3 for submission to the address below:

PWC Department of Public Works
Watershed Management Branch
5 County Complex Court, Suite 170
Prince William, VA 22192

6. Upon payment of all fees and receipt of all applicable items listed in item #3, County staff will add the project to the active Camera Van job list. County staff will strive to schedule and conduct an inspection within a timely manner; punch lists shall be generated based on the most current approved set of plans provided.
7. **Punch lists are valid for 1 year.** Within this time frame, the developer shall correct all deficiencies noted on the punch list and schedule a re-inspection of all punch list items in order to obtain final approval. All deficiencies should be corrected as soon as possible; waiting too long may add new items to the punch list upon re-inspection. ***This initial re-inspection is included in the original fee.***
8. The developer shall obtain final bond release within **1 year of initial** punch list date (not punch list completion date). Failure to correct punch list deficiencies within the 1-year time period will require the developer to begin the CC TV inspection process of the entire system **again**, including payment of all fees assessed.



**COUNTY OF PRINCE WILLIAM
DEPARTMENT OF PUBLIC WORKS**

Environmental Services Division
Watershed Management Branch
5 County Complex Court, Suite 170, DS-930
Prince William, Virginia 22192-5308
Main (703) 792-7070 Facsimile (703) 792-6297

**FY21 Closed Circuit Storm Sewer Inspection Request Application
(Effective July 1, 2020 - June 30, 2021)**

Staff Use Only

ILP # _____ Amount received (@ **\$2.33/linear foot**): _____
 Received by: _____ Date: _____ RCPT _____
 Emailed to CCTV Inspector Date: _____ Site Inspection Area: _____

(Complete Checklist Below)

- Most current cover sheet.
- One (1) set of full size (24"x36") Storm Plan/Grading Plan Sheets
- All applicable revisions involving storm drainage systems
- One (1) copy of Storm Profile Sheet
- One (1) copy of most current Unit Price List
- One (1) copy of the Storm Water Management Plan and Profile
- Payment amount listed in TOTAL AMOUNT DUE box

Before requesting an inspection, please make sure your site meets the minimum requirements listed on page 1, item #2. Please use checklist below for your reference:

- Base asphalt is laid down
- Storm drainage systems flushed, cleaned, and free of debris.
- All storm structures are set to their final grades- inverts, steps, tops, and grates installed.
- All structures to be inspected must be marked in field (per approved plan) prior to inspection.
- All storm water management facilities are accessible via camera van vehicle and to County staff

LND Number: _____

(Site Permit Number)

Approved Site Plan Number: _____

Approved Site Plan Name: _____ Section: _____ Phase: _____

Site Address: _____

Contact Name: _____ Number: _____

Print Name

Email: _____ Fax #: _____

FY21 fee currently \$2.33 per linear foot

1) Storm Sewer pipe footage (within proposed VDOT R/W)	L.F.
2) Storm Sewer pipe footage (within dedicated County easements)	L.F.
3) Storm Sewer pipe footage (within private easements)	L.F.
TOTAL LINEAR FOOTAGE TO BE INSPECTED (1 through 3)	L.F.
TOTAL AMOUNT DUE (\$2.33 / linear foot) (minimum fee: \$280.00)	

By signing below, I _____, certify that all information is accurate. I have read and understand the CCTV process. I also certify that my site is ready for inspection and all storm drainage pipe systems are cleaned, flushed, and pipe inverts are installed, structures for inspection are marked accordingly. I also certify that any steps, tops, or grates are installed and ready for County staff CCTV inspection as of this date: _____.

(Printed Name)

(Signature)



**COUNTY OF PRINCE WILLIAM
DEPARTMENT OF PUBLIC WORKS**

Environmental Services Division
Watershed Management Branch
5 County Complex Court, Suite 170, DS-930
Prince William, Virginia 22192-5308
Main (703) 792-7070 Facsimile (703) 792-6297

APPLICATION FOR EROSION & SEDIMENT CONTROL VARIANCE

LND#: LND _____ Variance #: VAR _____
Project Name: _____ Section/Phase: _____
Approved Plan #: _____ Receipt #: _____
Received by: _____ Plan Reviewer: _____

As of _____ (date), I have conducted a quality control review on the following:

- Five (5) copies of the approved site plan(s) applicable to the revision, Five (5) copies of the revised plan(s).
- A completed variance request application, **signed by the Area Site Inspector prior to submission at Watershed.**
- Variance review fee \$355.58

Print Name (Site Inspector)

Print Name (Developer/Representative)

Signature (Site Inspector)

Signature (Developer/Representative)

SECTION I - GENERAL INFORMATION

Applicant Name: _____

E-mail Address: _____ Telephone: _____

SECTION II - SPECIFICS OF VARIANCE REQUEST

RECOMMENDATION: Approval Approval with Condition(s) Denial

Condition(s):

Signature: _____ Date: _____



**COUNTY OF PRINCE WILLIAM
DEPARTMENT OF PUBLIC WORKS**

Environmental Services Division, Watershed Management Branch
5 County Complex Court, Suite 170, Prince William, Virginia 22192
Main: (703) 792-7070 Facsimile: (703) 792-6297

AS-BUILT PLAN ACCEPTANCE CONFIRMATION/TRANSMITTAL

Project Name: _____ Date _____
Due: _____
Approved Site Plan Number: _____ As-Built Plan Number: _____
Received by: _____ Plan Reviewer: _____

As of this date, _____, I have conducted a Quality Control Review on the following:

- Two (2) copies of the As-Built Plan (one for civil review, one for geotechnical review)
- One (1) copy of the Recorded Plat
- Completed As-Built submission checklist including all referenced items
- Impervious Area Calculation Sheet (if applicable)
- Copy of recorded Storm Water Management Facility Maintenance Agreement (if applicable)

Print Name (Site Inspector)

Print Name (Developer/Representative)

Signature (Site Inspector)

Signature (Developer/Representative)

Please submit As-Built package, signed As-Built Acceptance Transmittal (signed by the Site Inspector), and **\$369.12** fee (payable to Prince William County) to:

**Prince William County Department of Public Works
Environmental Services Division/Watershed Management Branch
5 County Complex Court, Suite 170, Prince William, VA 22192**

As-Built Point of Contact Information (person that will be notified of plan approval):

Company Name: _____

Attention: _____

Street Address: _____

City: _____ State: _____ Zip Code: _____

Email: _____

Phone: _____ Fax: _____



**COUNTY OF PRINCE WILLIAM
DEPARTMENT OF PUBLIC WORKS**

Environmental Services Division, Watershed Management Branch
5 County Complex Court, Suite 170, Prince William, Virginia 22192
Main (703) 792-7070 Facsimile (703) 792-6297

AS-BUILT SUBMISSION CHECKLIST

The submitted as-built plan shall include all approved coversheets (including revisions) with the name, address and phone number of the preparing firm, approved site grading sheets, and approved storm water management (SWM) and drainage computations.

Note: Construction Inspection: Inspections are needed during construction to ensure that the facilities are built in accordance with the approved plans and design specifications. The developer/owner shall provide for periodic inspections of the facility during construction. Detailed inspection checklists shall be used that include sign-offs by a licensed land surveyor or professional engineer registered in Virginia at critical stages of construction, to ensure that the contractor's interpretation of the plan is consistent with the designer's intent. The actual inspections may be performed by an individual under the direct supervision of the licensed professional [(DCSM Section 721.02(B) (11)].

**Legend: APM - Administrative Procedures Manual
DCSM - Design and Construction Standards Manual**

<u>REF. SECTION</u>	<u>REGULATIONS</u>	<u>YES</u>	<u>NO</u>	<u>N/A</u>
APM 4.12.2	Impervious Area Certification shall be submitted for commercial, industrial, and multi-family properties.			
APM 4.12.1.A.2	Horizontal location of storm sewers with one (1) tie for all storm structures. All ties shall be affixed to permanent objects (i.e. building corners, fire hydrant).			
APM 4.12.1.B	Invert elevations (in and out) for all storm sewers, and invert of structures			
APM 4.12.1.C	Length, size, percent slope, and type of material used for all storm sewer and storm water management (703.02.B.1)			
APM 4.12.1.D	Top of structure elevation on all storm sewer structures			
APM 4.12.1.E	As-built topography for Storm Water Management/Best Management Practices, Low Impact Designs and verification of as-built storage volume with the approved design.			
APM 4.12.1.F	Detailed as-built information for special design drainage and storm water management structures			
APM 4.12.1.G	As-built elevations including centerline, cross sections and slopes of channels, swales, channel outfalls, and outfall protections and downstream of outfall pipes located within drainage easements. A typical as-built ditch section shall be shown on the plan.			
APM 4.12.1.H	All dedicated easements shall be shown. The cover sheet of the plan and plat shall show the deed book and page numbers in which the easements are recorded.			
APM 4.12.1.I	A graphic scale and north arrow shall be shown on each as-built plan sheet.			
APM 4.12.1.J	Any changes/revisions from the approved construction plan shall be indicated by circling the changes in red with written explanation for the changes by the engineer			
APM 4.12.1.K	Except for the storm water management, best management			

REF. SECTION	REGULATIONS	YES	NO	N/A
	practices, and the low impact designs, the as-built certification of physical survey (statement is listed in APM) shall be dated within one year of submission (the physical survey itself shall be within one year of submission) to the County for review.			
APM 4.12.1.K	Each as-built sheet shall be signed, sealed, and dated.			
DCSM 702.02 (A)	Provide as built topographic survey of the overland relief for the one hundred (100) year storm event.			
DCSM 702.02 (D)	Hydraulic grade line and computations for as-built conditions for drainage system not built according to the approved plan			
DCSM 702.10 (B) and (C)	As built certifications for storm sewer anchors/cut off walls added to the plan			
DCSM 110.11	The as-built information (i.e. physical survey) pertaining to the storm water management facilities, best management practices, and low impact designs shall be current within 6 months of submission to the County for review			
DCSM 770.50 (B)	As-built location and elevations of Retaining walls by the professional engineer or land surveyor , and certification from the geotechnical engineer of record			
DCSM 721.10 (A) and (B)	SWM access road width and grade, embankment width, gate, and fencing (721.11(A) and (B) for details).			
DCSM 722.04 (B)	An electronic spreadsheet shall be submitted with the following information along with the as-built plan: <ol style="list-style-type: none"> 1. <u>SWM/BMP Facility</u> <ol style="list-style-type: none"> a. SWM/BMP Facility Type b. Location c. Subdivision/Site Name d. Hydrologic Unit Code (HUC) of the receiving stream. <i>*(in most cases, the HUC of the development) ("HUC" means a watershed unit established in the most recent version of Virginia's 6th Order National Watershed Boundary Datasheet)</i> e. Total acres treated (BMP Acres) f. Year Built g. Land Use (commercial, single family, industrial, etc.) h. Latitude and longitude of the facility. i. Maintenance (County/ private) j. Copy of maintenance agreement (if applicable) 2. <u>Each Outfall</u> <ol style="list-style-type: none"> a. Size of outfall (diameter or equivalent) b. Subdivision/Site Name c. Hydrologic Unit Code of the Receiving Stream (Development) d. Drainage Area to the outfall e. Year Built f. Land Use g. Latitude and Longitude 			
DCSM 722.04 (C)	A completed "construction inspection and as-built survey checklist", certified by a professional engineer or surveyor verifying that the storm water management facilities and associated conveyance systems have been built in accordance with the approved plan and design specifications. The completed checklist shall be incorporated on the plan.			
DCSM 722.02 (J)	Copy of recorded Storm Water Management/Best Management Practices maintenance agreement.			
DCSM 722.02 (K)	Approved and as-built Storm Water Management fact sheets. Rerouting of the pond is required if as-built conditions deviate significantly from the approved plan.			
DCSM 732.01(A)	Letter of Map Amendment or Revision from Federal Emergency Management Agency			
DCSM	The written certification shall include all geotechnical elements, but			

REF. SECTION	REGULATIONS	YES	NO	N/A
770.50 (A) and (B)	is not limited to, the type of material, compaction, depth and spacing of piles/piers, location, length, spacing, strength and type of geogrid, and ground cover to protect the slope as specified, and any other stabilization measures as recommended in the approved geotechnical report. The GER shall verify and certify that the final slope is in accordance with the slope approved in the geotechnical report at the time of as-built plan submission.			
DCSM 770.50C	The Site Civil Engineer of Record (SER) or a Land Surveyor duly licensed in the Commonwealth of Virginia shall provide a written certification on the gradient of the constructed slope as directed by County staff.			
DCSM 721.08	Setbacks from the 100 year WSE to the structure and the property line.			
DCSM 721.02 (B) (12)	<u>As-Built Certification:</u> After the facility has been constructed, the developer shall have an as-built certification conducted by a licensed land surveyor or professional engineer registered in Virginia and submitted to the County along with the as-built checklist and as-built plan. The as-built certification verifies that the facility was installed as designed and approved.			
Policy	Interior curb with spot elevations where inlets are provided			
Virginia Dam Safety Regulations 725.00(D)	Submit two DCR approved copies of all the documentation (i.e. Operation and Maintenance Plan, Inundation Zone Maps, Emergency Action Plan, etc.....) as well as one soft copy related to Virginia regulated impoundment structures to the County for its records as well as for facilitating emergency operations. Site finalization and final bond release is subject to meeting this requirement.			



Storm Water Management and BMP Facility Installation

Before installation of any of these facilities commence, it is required that the Site Inspector be notified. The following criteria applies to the installation of ALL Proprietary and Non- Proprietary facilities.

- Construction inspections must be made by a qualified installer under the direction of a Certified Land Surveyor in the state of VA or a Professional Engineer.
- A BMP checklist is required for each of these facilities. This checklist must be accurately filled out and documented in the SWPPP booklet on site. Each facility has its own specific applicable checklist.
- These BMP Checklists are required to be included in the As-built submission.
- Color Photo documentation is required at the various stages of construction as noted on the checklists.
- Checklists located at : <https://www.pwcgov.org/government/dept/publicworks/Pages/VSMP.aspx>

Non-Proprietary Facilities Include:

1. Simple Disconnect.
2. Sheet Flow.
3. Grass Channel.
4. Soil Compost.
5. Vegetated Roof.
6. Rainwater Harvesting.
7. Permeable Pavement.
8. Infiltration.
9. Bio-Retention.
10. Dry Swale.
11. Wet Swale.
12. Filtering Practice.
13. Constructed Wetlands.
14. Wet Pond.
15. Extended Detention Pond. (Dry Pond).

Proprietary Facilities Include:

Filtering Manufactured Devices		
EMC %TP Removal Efficiency*	MTD Name	Manufacturer [†]
20	StormTank Module Debris Row	Brentwood Industries
40	Aqua-Filter™ Stormwater Filtration System	AquaShield™, Inc.
40	StormTech® Isolator Row™	StormTech - A Division of Advanced Drainage Systems, Inc.
40	Up-Flo Filter® with CPZ media	Hydro International
45	The Stormwater Management StormFilter® with ZPG media	Contech Engineered Solutions LLC
50	BayFilter™ Stormwater Cartridge System	Baysaver Technologies LLC
50	Filtterra Bioretention Systems	Contech Engineered Solutions LLC
50	FocalPoint High Performance Modular Biofiltration System (HPMBS)	Convergent Water Technologies, Inc.
50	Jellyfish® Filter	Contech Engineered Solutions LLC
50	Modular Wetland System Linear (MWS-Linear)	Modular Wetland Systems, Inc.
50	Perk Filter	Oldcastle Stormwater Solutions
50	The Stormwater Management StormFilter® with Phosphosorb media	Contech Engineered Solutions LLC

Hydrodynamic Manufactured Devices		
EMC %TP Removal Efficiency*	MTD Name	Manufacturer [†]
20	Aqua-Swirl® Stormwater Treatment System	AquaShield™, Inc.
20	BaySeparator™	Baysaver Technologies LLC
20	Continuous Deflective Separator® (CDS)	Contech Engineered Solutions LLC
20	Downstream Defender®	Hydro International
20	Dual Vortex Separator (DVS)	Oldcastle Stormwater Solutions
20	First Defense®	Hydro International
20	Hydroguard	Hydroworks, LLC
20	Stormceptor® MAX	Rinker Materials Stormceptor®
20	Stormceptor® OSR	Rinker Materials Stormceptor®
20	Stormceptor® STC	Rinker Materials Stormceptor®
20	StormPro	Environment 21, LLC
20	Storm Water Quality Unit	Advanced Drainage Systems, Inc. (ADS)
20	Terre Kleen™ Hydrodynamic Separator	Terre Hill Concrete Products
20	V2B1	Environment 21, LLC
20	The Vortechs® System	Contech Engineered Solutions LLC
25	CrystalClean Separator – Single Vault	CrystalStream Technologies